

Ruckus™ Collection Price List ■

February 22, 2017
800-424-2432



Ordering C.O.M., C.O.L., and C.O.V.	
Bonduel, Green Bay, Ontario, and Tupelo and Shipping Location	2

General Information	
Ruckus™ Options User Guide	4
Ruckus™ Seating	6
Ruckus™ Desking	10
Ruckus™ Storage	12

Ruckus™ Seating (Freight Excluded Pricing)	
Four-Leg Chair	14
Stack Chair with Glides	18
Stack Chair with Casters	22
Stools	26
Task Chair	30

Ruckus™ Desking (Freight Excluded Pricing)	
Desk	32

Ruckus™ Storage (Freight Excluded Pricing)	
Lockers	36
Bookcase	40
Cubbies	42
Storage Accessories	46

Ruckus™ Seating (Delivered Pricing)	
Four-Leg Chair	48
Stack Chair with Glides	52
Stack Chair with Casters	56
Stools	60
Task Chair	64

Ruckus™ Desking (Delivered Pricing)	
Desk	66

Ruckus™ Storage (Delivered Pricing)	
Lockers	70
Bookcase	74
Cubbies	76
Storage Accessories	80

Index	82
--------------	----

Ordering C.O.M., C.O.L., and C.O.V.

Bonduel, Green Bay, Ontario, and Tupelo and Shipping Location

How to Specify C.O.M. Upholstery

Textile designs often have intricate patterns. Not all individuals will interpret fabric direction in the same manner.

As a standard procedure, KI cuts fabrics off the roll in a horizontal fashion as shown in Diagram A at the right. By cutting in this fashion, most waste is eliminated. Our requirements for yardage in this book are based on this type of cutting. When directional or patterned fabrics are used, they often require more yardage than solid colors.

By providing KI with a completely filled-out copy of the form on this page, we will be able to expedite your order. We find it particularly helpful with directional or patterned upholstery material. It is critical that copies of this form accompany test quantities as well as production quantities of C.O.M.

C.O.M. must be supplied in continuous yardage.

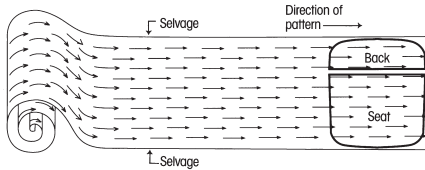

C.O.M., C.O.L. and C.O.V. Testing

KI will require for testing actual yardage to upholster one chair. The testing requirements depend on which chair you have selected on your order.

Test samples will be applied to the order and will be held for 6 months if needed. After 6 months, the sample can no longer be applied to your order. For all products to be tested, send test samples for approval to:

KI
Attn: C.O.M. Specialist
1687 Westminster Drive, Gate 3
Green Bay WI 54302

To expedite the procedure, attach a copy of the "C.O.M. Information Form" on this page.

All C.O.M., C.O.L. and C.O.V. must be labeled with the purchase order number.

C.O.M., C.O.L. and C.O.V. Production

Customer's fabrics and leathers must be approved prior to acceptance for production. Upon test approval, a 1" square sample swatch of upholstery material must accompany the order. KI assumes no responsibility for wear, defects or performance of customer's own fabrics, vinyl or leather. C.O.M., C.O.L. and C.O.V. orders are available on a deferred delivery basis.

Orders for production of C.O.M., C.O.L. and C.O.V. upholstered products are not scheduled for processing until upholstery material is received. Upon receipt, KI will provide an acknowledgement and an estimated shipping date.

KI recommends that leather be ordered in yardage. Leather must be usable. The outer edges cannot be calculated as square feet or yardage.

The C.O.M., C.O.L. and C.O.V. yardage requirements accompanying products in the pricing section are for 10 chairs/seats or less, 54" wide nondirectional material. On larger orders, less material is required.

For exact production yardage requirements, call 1-800-424-2432, ext. 2707.

C.O.M., C.O.L. and C.O.V. Order Processing

For products shipped from Green Bay, WI facility, ship upholstery material to:

KI
Attn: C.O.M. Storage
1687 Westminster Drive, Gate 3
Green Bay, WI 54302

For products shipped from Tupelo, MS facility ship material to:

KI Tupelo
Attn: C.O.M. Storage
2112 South Green Street
Tupelo, MS 38801

For products shipped from Bonduel, WI facility, ship material to:

KI
Attn: C.O.M. Storage
204 West South Street
Bonduel, WI 54107

For products shipped from Ontario, CA facility, ship material to:

Avail/Impress/Kismet/Medical & Laboratory Stools/Pilot
Attn: C.O.M. Storage
1110 S. Mildred Ave.
Ontario, CA 91761

Intricate Patterns

In the event of specific requirements for positioning of intricate patterns or pattern repeats on seats and backrests, provide a sketch noting requirements, as in Diagram B, along with materials for testing, and with the order.

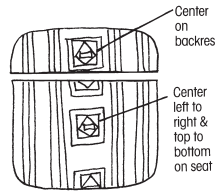

Diagram B

Treated Materials

If C.O.M. requires processing such as Scotchgard® or acrylic backing, it often shrinks. To prevent delays in delivery or back ordering due to shrinkage, please have your processor remeasure after processing and assure adequate yardage shipment.

Split Orders

If a portion of the shipment which does not require C.O.M., C.O.L. or C.O.V. applications is to be processed and shipped early, KI will enter the order immediately at your request. These split shipments are subject to minimum order changes.

Contact the C.O.M. Specialist at 1-800-424-2432, ext. 2707, with questions or to verify a split order.

Excess Upholstery Material

KI will dispose of excess upholstery material at the time of shipment unless expressly requested to return it with the product shipment.

Cancelled or Changed Orders

KI assumes no responsibility for extra C.O.M., C.O.L. or C.O.V. material due to a change of upholstery or cancellation of an order. It is the customer's responsibility to arrange for return of this material.

C.O.M., C.O.L. and C.O.V. Information Form

A copy of this form should accompany test requests and production orders. Please fill it out completely, and, if your order has been acknowledged, provide the acknowledgement number.

Purchasing Agent (Dealer or buying organization) _____
 Attention _____
 Address _____
 City _____ State _____ Zip _____
 Project Name _____
 Type of seating and number of units of each type _____

Please see information below and check the appropriate box.

Submitted for testing.

Test approved. Submitted for production.

Purchase Order Number _____

KI Acknowledgement Number _____

In all instances, send this form to the C.O.M. Specialist.

A Selvage Top and Bottom



B Selvage Side and Side





C.O.M. SHIPPING LOCATION

Architectural Walls

Genius Walls MN

Casegoods

Dante Benches AG
Darwin Tackboards MN
Aristotle Tackboards MN

Classroom Furniture

360° Classroom Furniture BW
Dorsal 1090 Chairs GB
Intellect Wave Chairs GB
Learn2 GB

Desking

700 Series Desking KP
Balance Overheads MN
Genesis Desking MN
True Desking KP
Universal Overheads MN
WorkZone Desking MN

Files & Storage

700 Series Pedestal Cushion GB
Connection Zone Pads BW
U-Series Pedestal Cushion GB

Fixed Seating

Concerto Auditorium Seating BW
Single Pedestal Seating GB
Jury Base Seating GB
Hi5 GB
Lancaster Auditorium Seating BW
Sequence Seating GB
University Seating GB

Panel Systems

All Terrain KP
Balance Overheads MN

System 3000 MN
Universal Overheads MN
Wireworks MN
Unite MN

Residence Hall Furniture

RoomScape Furniture MN

Screens

All Terrain KP
Connection Zone BW
True/Volition KP
Genesis KP

Seating

100 Series Folding Chairs BW
300 Series Folding Chairs BW
600 Series Stools BW
700 Series Folding Chairs BW
1000 Series GB
1100 Series Folding Chairs BW
Aerdyn Guest Seating HN
Affina Collection HN
Arissa Lounge HN
Altus Task Chairs TM
Apply Stack Chairs GB
Auditorium Folding Chairs BW
Avail Task Chairs OM
Bantam Guest Seating HN
Boss Design Chairs HN
Cinturon Lounge & Professional Seating HN
Cody Lounge Seating HN
Connection Zone Privacy Booths HN
Doni Collection GB
Dorsal Stack & Tandem Seating GB
Engage Task Chairs & Stools GB
Front Row Seats (Silk Screening) BW
GateOne Public Seating BW
Grazie Seating GB

Hub Modular Lounge Seating HN
Impress Task Chairs OM
Impress Ultra Task Chairs OM
Jessa Lounge Seating HN
Jubi Guest Chair GB
Kismet Task/Guest Chairs & Stools OM
Kurv Benches HN
LaResta Day Beds HN
Lyra Lounge Seating HN
Maestro Stack Chairs GB
Matrix Stack Chairs GB
Medical & Laboratory Stools OM
Mesa Lounge & Task Seating HN
MyWay Seating HN
Neena Benches HN
Opt4 GB
Perry Stack Chairs GB
Perth Multiple & Healthcare Seating HN
Perth II Healthcare Seating HN
Pilot Task Chairs OM
Piretti Stack Chairs GB
Promenade Seating System BW
Rapture Stack Chairs & Stools GB
Ruckus GB
Rose Healthcare BW
Sela Lounge Seating HN
Sift Task Chairs TM
Silhouette Stack Chairs & Stools BW
Soltice Metal Collection HN
Soltice Multiple, Healthcare & Guest HN
Soltice II Healthcare Seating HN
Strive Multiple, Stack & Task GB
Sway BW
Tea Cup Lounge Seating HN
Torsion-on-the-Go! Nesting Chairs GB
Torsion Air Stack and Task Seating GB
Torsion Stack and Task Seating GB
Versa Stack Chairs & Stools GB



KI Manufacturing Sites - Customer's Own Material Shipment Manufacturing Site Addresses

AG

Contact KI at
1-800-424-2432

GB

KI Green Bay
Attn: COM Storage
1687 Westminster Drive - Gate 3
Green Bay, WI 54302

KP

KI Pembroke
Attn: COM Storage
1000 Olympic Dr.
Pembroke, Ontario K8A6X7

MN

KI Manitowoc
Attn: COM Storage
1400 S. 41st St.
Manitowoc, WI 54220

BW

KI Bonduel
Attn: COM Storage
204 West South St.
Bonduel, WI 54107

HN

KI-HN
Attn: COM Storage
217 Feld Avenue
High Point, NC 27263

OM

KI
Attn: COM Storage
1110 S. Mildred Ave.
Ontario, CA 91761

TM

KI Tupelo
2112 South Green St.
Tupelo, MS 38804

General Information

Ruckus™ Options User Guide



Build a Model - Seating

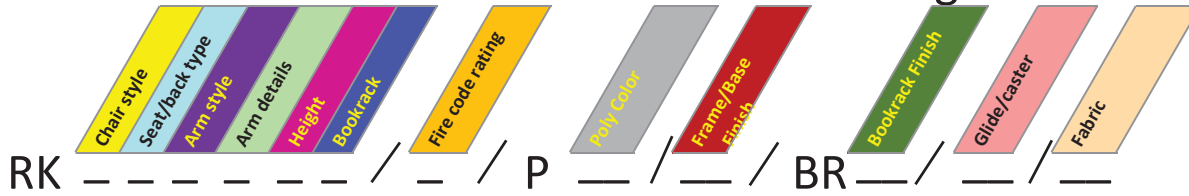

Chair style
 1 - 4 Leg on Glides
 2 - 4 Leg on Casters
 4 - Cafe Stool
 5 - Simple Function Task
 U - Stack on Glides
 V - Stack on Casters

Seat/back type
 1 - No UPH Solid Color Poly
 2 - UPH Seat Only Solid Color Poly

Arm style
 0 - Armless

Arm details
 0 - Armless

Height
 H15 - 15"
 H18 - 18" } Chair Heights
 H24 - 24"
 H30 - 30" } Stool Heights
 Note: Blank for Simple Function Task

Bookrack
 BR - Bookrack
 NB - No Bookrack
 Note: Blank for Simple Function Task

Fire Code Rating
 FR - Fire Retardant
 NFR - Non Fire Retardant

Poly Color
 Pxx - Poly Color

Frame/Base Finish

Glide/caster
 GPL - Plastic Glide
 GSL - Steel Glide
 GFT - Felt Glide
 CCC - Carpet Caster
 CHC - Hard Floor Caster

Fabric

Bookrack Finish
 BRxx - Bookrack Color

Examples:

RK1100H15NB/NFR/PZL/SX/GPL
 Ruckus, 4 leg on glides, no UPH solid color poly, armless, 15", no bookrack, non FR, Zesty Lime poly, Starlight Silver frame, plastic glides

RKV200H18BR/NFR/PCG/GR/BRCH/CCC/1ZJE
 Ruckus, stack on casters, UPH Ssat only solid color poly, armless, 18", bookrack, non FR, Cool Grey poly, Grey frame, Chrome bookrack, carpet casters, fabric Zone Jade

RK5100/FR/PSA/BL/CHC
 Ruckus, simple function task, no UPH solid color poly, armless, FR, Sand poly, Black frame, hard floor casters

Guideline only. Subject to change.



Build a Model - Desking

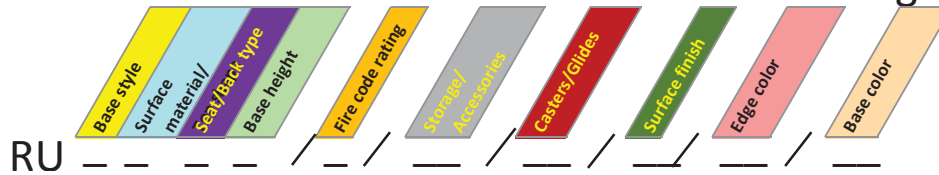

Base style
4 - Single Post Cantilever
5 - Single Post Rolling Cantilever

Surface material/top shape
2 - Laminate Rectangular Curved Front

Seat/Back type
0 - N/A

Base height
1 - Fixed 29" Height
7 - Fixed 26" Height

Fire Code Rating
NFR - Non Fire Retardant

Storage/Accessories
BH- Book bag hook
NB - No book storage

Casters/Glides
GPL - Plastic Glide
GSL - Steel Glide
GFT - Felt Glide
RPL - Rolling Front/Rear Plastic Glide
RSL - Rolling Front/Rear Steel Glide
RFT - Rolling Front/Rear Felt Glide

Surface Finish
Lxx - Laminate Color

Edge Color
Exx - Edge Color

Base Color

Examples:
RU4201/NFR/BH/GPL/LBA/EBL/CH
Ruckus desk, single post cantilever, laminate rectangular curved front, fixed 29" height, non FR, book bag hook, plastic glide, laminate Beige Nebula, edge black, chrome frame
RU5207/NFR/NB/RFT/LGN/EWG/RK
Ruckus desk, single post rolling cantilever, laminate rectangular curved front, fixed 26" height, non FR, no book storage, rolling front/rear felt glide, laminate Graphite Nebula, edge warm grey, rubber ducky frame

Guideline only. Subject to change.

General Information

Ruckus™ Seating

Ruckus Seating

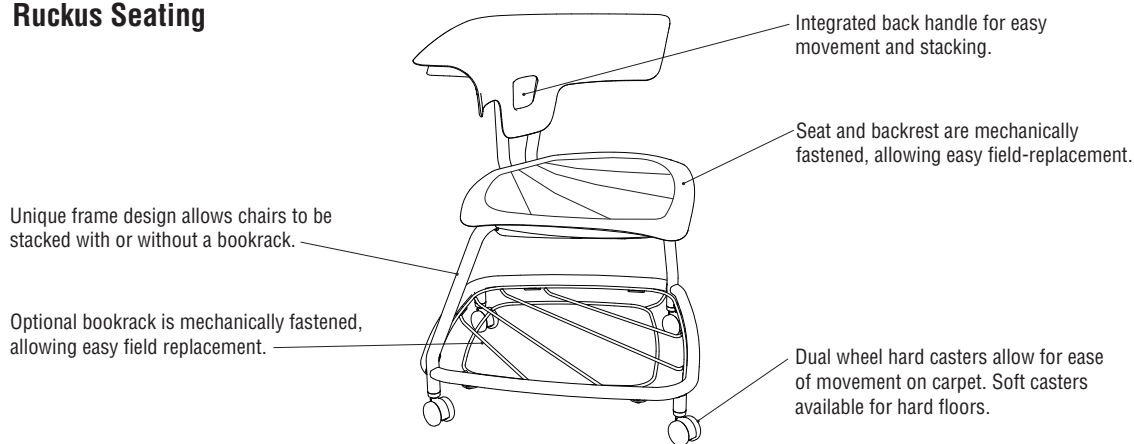

RUCKUS SEATING

Description

Ruckus promotes student movement through its unique design. Its generously sized seating encourages an "as you like it" sitting experience. The chair back shape includes integral armrests, which are also engineered to function as a support surface.

Seat and Backrest

Both the seat and backrest shell shall be made of static-free high-impact 7% fiberglass reinforced polypropylene. Colorfastness is ensured through complete color impregnation throughout the molded part. Textured on both sides with a contrasting texture pattern on the seat. Ergonomic handle molded into the chair backrest for ease of mobility. Seat and backrest fasten to the frame with six 1/4-20 x 3/4" Hi-Lo screws.

Optional Upholstered Seat

Upholstered seats have partially exposed

polypropylene surfaces. Molded Urethane foam is attached to an injection-molded polypropylene liner board, then upholstered using a draw-string process and fastened to an inner shell with screws. Seat foam is molded nominal 1" thickness.

Frames

Four Leg, Stack, Stool and Task frames are constructed with 1" outside diameter 13-gauge steel tubing, welded to 13-gauge steel plates and 1/4" wire. Frame shall be nickel-chrome plated or finished in powdercoat paint after all welding processes are complete.

Glides

Stack, Stool & Four Leg Chairs - Swivel-type polished zinc-plated steel, nylon plastic, or felt glides. KI recommends consulting with the floor manufacturer for specific glide recommendations.

Note: Felt glides add 1/4" to the overall height range.

Task Chair - Optional Bell glides (2" high) made of high impact thermoplastic. High-impact plastic frame. Black finish only.

Note: Bell glides add 1/4" to the overall height range.

Casters

Carpet Casters Option - 50mm double wheels of high-impact thermoplastic. High-impact plastic frame. Black finish only.

Hard Floor Casters Option - 50mm double wheels of soft plastic. High-impact plastic frame. Black finish only.

NOTE: Casters not available on stool models.

Task Chair

Pneumatic Height Adjustment
Lever-activated pneumatic cylinder enables seat-height adjustment from 16-1/2" to 21-1/4".

Five Blade Base

28" injection molded, 30% fiberglass reinforced nylon 5-blade base. Available in Black

or Warm Gray.

Bookrack

Stack Chair Frame - Optional bookrack is a welded framework of 1/4" diameter solid wire welded to eight 1/8" thick plates. Fastened to stackable chair frame with eight #10 screws. Bookrack will be nickel-chrome plated or finished in powdercoat paint after all welding processes are complete

Testing

Ruckus chair components shall originate from ISO 9000, ISO 9001 or ISO 9002 registered facilities. Ruckus chairs are designed and manufactured to meet or exceed required ANSI/BIFMA X6.1-2012 Education Seating and ANSI/BIFMA X5.1-2011 General Purpose Office Chairs.



General Guideline for Glide Selection

The following information is based on a combination of testing and experience. Due to factors beyond our control, KI is presenting this information strictly as a general guideline to assist our customers in selecting the best glide for their situation. It is up to the customer to determine which glide will perform best for their application based upon their site conditions, requirements, and the direction of the flooring manufacturer. Sample glides are available upon request to aid the customer in their selection (contact Customer Service).

Price list glide choice of: Nylon, Steel or Felt



Nylon



Steel



Felt - Solo Glide®

PERFORMANCE GUIDE (clean and properly finished floors)

GLIDE MATERIAL	CARPET	RESILIENT FLOORING			HARD FLOORING		
		Vinyl Sheet	VCT	Rubber	Ceramic Tile	Concrete	Hardwood
Nylon	★★	★★	★★	★★	★★	★★	NR
Steel	★★	★	★	★	NR	NR	NR
Felt	NR	★	NR	NR	NR	NR	★★

★★ = Best Performance

★ = Acceptable Performance

NR = Not Recommended

Steel glides are not recommended for light colored floors.

The following factors affect the performance of any glide:

- Floor Quality – Materials and manufacturing processes for a specific floor type can vary considerably depending upon the manufacturer and product grade. Floor grades with higher stain and abrasion resistance will typically perform better.
- Floor Preparation – The quality and frequency of application of the floor finish will significantly affect the amount of wear. A high quality finish will act as a lubricant between the chair and floor to minimize wear.
- Floor Maintenance – Any glide material will leave marks if the floor is not properly cleaned. The use of walk-off rugs near entrances, along with frequent cleaning of the floors, will significantly reduce damage to floors. Steel glides should not be exposed to wet or damp floors.
- Damaged Glides – Periodic inspection of glides is critical to preventing floor damage. Glides that are damaged, worn or have embedded debris should be replaced immediately. Felt caps wear faster and should be replaced frequently.

INFORMATION

Warranty

Refer to KI Terms & Conditions document or visit ki.com

General Information

Ruckus™ Seating



Four-Leg Chair



Stack Chair



Task Chair



Stool

Features				
Stacking		•		•
Bookrack		•		•
Poly, or upholstered seat	•	•	•	•
General Dimensions				
Seat Width x depth	See chart	See chart	See chart	See chart
Seat Height	See chart	See chart	See chart	See chart
Overall Dimensions				
Width x depth	See chart	See chart	See chart	See chart
Height	See chart	See chart	See chart	See chart
Stacking on Floor-18" Frames				
Overall Width	n/a		n/a	
Overall Depth	n/a		n/a	
Quantity/Height	n/a	4 poly/3 uph	n/a	
Stacking on Floor-15" Frames				
Overall Width	n/a		n/a	
Overall Depth	n/a		n/a	
Quantity/Height	n/a	3 poly/2 uph	n/a	
Stacking on Floor-30" Frames				
Overall Width				
Overall Depth				
Quantity/Height				3 poly/3 uph
Stacking on Floor-24" Frames				
Overall Width				
Overall Depth				
Quantity/Height				3 poly/3 uph

Recommended Chair and Desk Heights

CHAIRS measured to top of seat	10"	12"	13"	14"	15"	16"	18"
DESKS without book box		22"		24"	25-26"	27"	29-30"
GRADE LEVEL							
Pre-K							
K							
1							
2							
3							
4							
5 and up							



General Dimension			
Seat Height	A	B	C
	Seat Depth 1	Seat Width	Seat Depth 2
15"	18.8"	22.3"	16.7"
18"	18.8"	22.3"	16.7"

Chair Overall Dimensions							
Seat Height	D	E	F	G	H	I	J
	Width 1	Width 2	Depth 1	Depth 2	Height	Seat Height	Backrest Height
15"	22.8"	28"	22.8"	29"	25.5"	15"	10.4"
15" (upholstered seat)	22.8"	28"	22.8"	29"	25.5"	16.3"	10.4"
18"	22.8"	28"	22.8"	29"	29.5"	18"	11.4"
18" (upholstered seat)	22.8"	28"	22.8"	29"	29.5"	19.3"	11.4"
24" Stool	22.8"	28"	22.8"	29"	35.5"	24"	11.4"
24" Stool (upholstered Seat)	22.8"	28"	22.8"	29"	35.5"	25.3"	11.4"
30" Stool	22.8"	28"	22.8"	29"	41.5"	30"	11.4"
30" Stool (upholstered Seat)	22.8"	28"	22.8"	29"	41.5"	31.3"	11.4"
Task Chair	22.8"	28.25"	22.8"	27.67"	28"-32.75"	16.5"-21.25"	11.4"
Task Chair (upholstered Seat)	22.8"	28.25"	22.8"	27.67"	28"-32.75"	17.7"-22.4"	11.4"

Felt and Bell glides add 1/4" to height dimensions

Dimensions are consistent for both 4-Leg & Stack Chair options

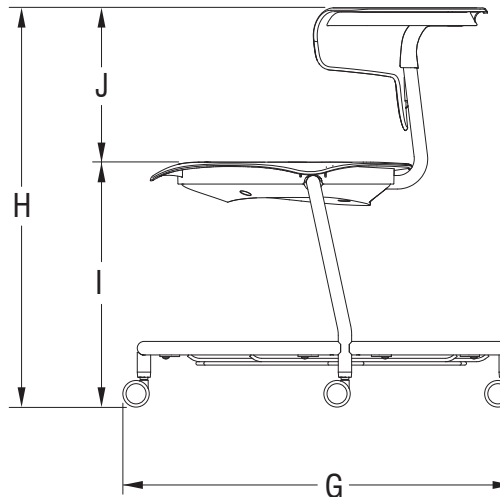
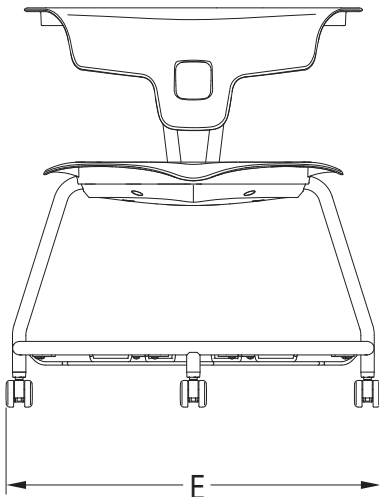
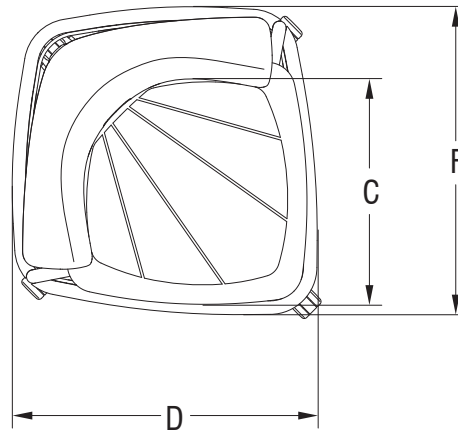
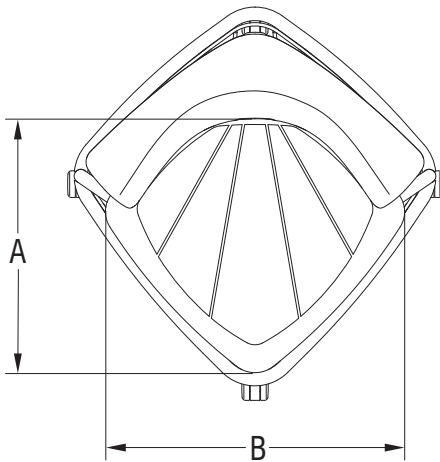

General Information

Ruckus™ Desking

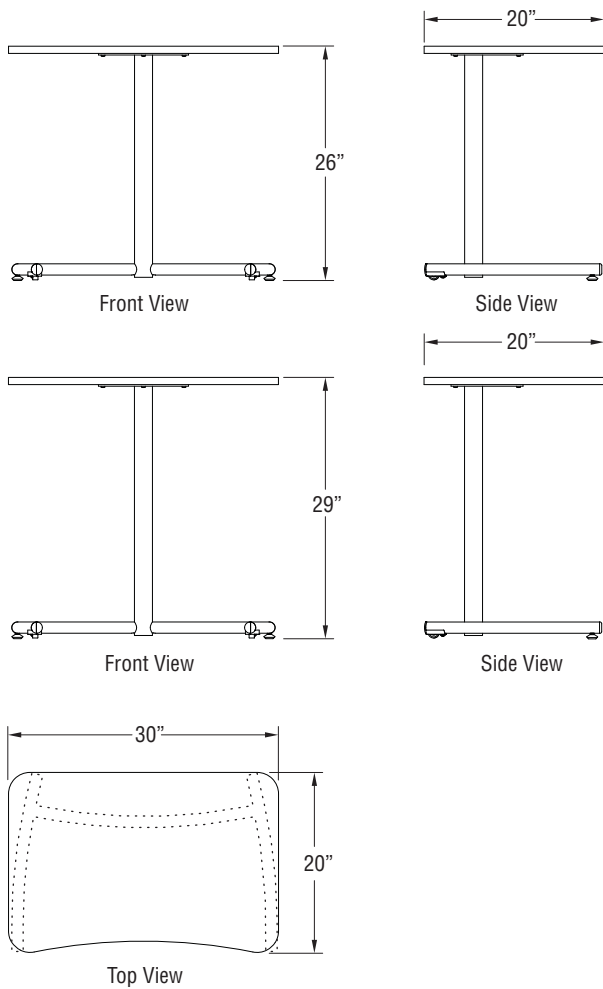

RUCKUS DESKING

Fixed-Height Desk – Single-Post Cantilever

Frames are constructed with 2" and 1-1/4" by 14-gauge steel tubing welded to a 7-gauge steel plate. Frame shall be nickel-chrome plated or finished in powder-coat paint after all welding processes are complete.

Rolling Base Model (wheelbarrow)

Rolling base model includes two rollers located on the non-user side of the frame with two swivel glides located on the user side for ease or mobility. Roller will be constructed of two piece molded polycarbonate housing with steel axle supporting a 1-1/4" diameter wheel constructed of high impact styrene and secured to base frame with a 1/4-20 x 5/8" screw. Cantilever frame shall include cutouts to encapsulate roller assembly.

Swivel-type polished zinc-plated steel,

nylon plastic, or felt glides. KI recommends consulting with the floor manufacturer for specific glide recommendations.

Note: Felt glides increase product height by 1/4".

Top

Top consists of high-density particleboard core covered with .030" high-pressure laminate top and a 0.02" phenolic backing sheet and 73P polypropylene edge with a finished top thickness of 3/4". Worksurface includes a curved front comfort curve on user side and 2-3/8" radius corners. Worksurface measures 20" x 30".

Glides

Swivel-type polished zinc-plated steel, nylon plastic, or felt glides. KI recommends consulting with the floor manufacturer for specific glide recommendations.

Note: Felt glides increase product height by 1/4". (See Seating General Information for General Guideline for Glide Selection.)

Book Bag Hook

Optional book bag hook is formed from 1/4" solid wire rod. Chrome finish provides long lasting wear resistance. Hook fastens to underside of laminate top with two #12 x 3/4" Phillips pan-head screws.

Testing

Ruckus desking components originate from ISO 9000, ISO 9001 or ISO 9002 registered facilities. Ruckus desking is designed and manufactured to meet or exceed required ANSI/BIFMA X5.5-2014 Desking.



Ruckus Desking

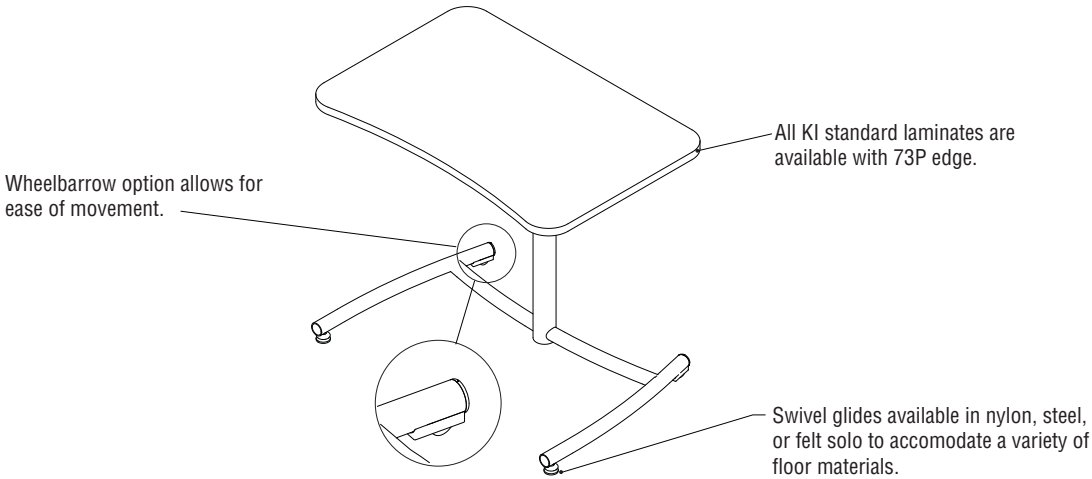
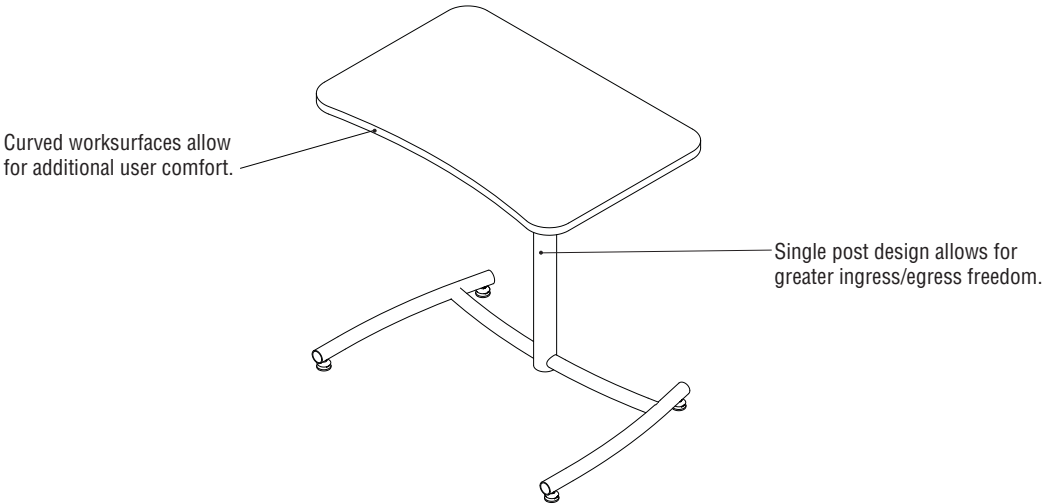

INFORMATION

Warranty
Refer to KI Terms & Conditions document or visit ki.com

General Information

Ruckus™ Storage

RUCKUS STORAGE

Assembly

All units are shipped fully assembled with the exception of casters or glides. Casters or glides are shipped loose and are assembled in the field. Units are shipped upside down for ease of end user to install casters or glides.

Shell Unit

The shell is made up of one common laminate top, mounted to the underside are vertical steel panels consisting of two outer end panels and one or two center panel(s). One center divider is screw mounted in each section to separate the front and back sides. All panel bottoms are mounted on one common steel base.

Overall size with casters or glides included:
Nominal vs. Actual

36w x 24d x 36h units:
36-1/8" wide x 24-3/8" deep x 36" high
36w x 24d x 42h units:
36-1/8" wide x 24-3/8" deep x 42" high
54w x 24d x 36h units:
53-5/8" wide x 24-3/8" deep x 36" high
54w x 24d x 42h units:
53-5/8" wide x 24-3/8" deep x 42" high

Laminate Worksurfaces

The laminate worksurfaces shall be 1-1/4" thick and shall consist of a particleboard core with a HPL surface. 74P (2mm PVC-free) banding is applied to the edges. All tops are pre-drilled for mounting of end panels, center panel(s) & center dividers and assembled in the factory.

Panels

Each 1" thick panel shall feature a double-wall steel construction. The outer panel shall be 20-gauge material with double flanges formed on both vertical edges and single flanges formed on the top and bottom. The vertical edges of the outer panel shall have an 18-gauge reinforcing member welded in place to provide structural integrity. The inner panel shall be 18-gauge with double flanges formed on the vertical edges and single flanges formed on the top and bottom edges. Two keyhole pads of 16-gauge shall be welded into the top of the end panel to interface with shoulder screws for mounting to the laminate top. The outer and inner panels shall be spot welded together, as well as fastened together at the bottom with the threaded inserts that accept the mounting bolt for the base. Bonded to both surfaces within the panel shall be a lightweight honeycomb core material to improve panel rigidity. All panels shall feature pre-punched holes for connecting the center dividers, shelves, coat hook, hinge mounts and slot for lock engagement.

Center Divider

One center divider is screw mounted in each section to separate the front and back sides. This is constructed of 20-gauge material with 3/4" side flanges for mounting. The divider is designed to not allow removal

unless access is available on both sides. This acts as a security feature when locker doors are used.

Bases

The 1 1/8" thick base ties together the panels creating the bottom and complete structure. Bases are 18-gauge steel. Each base consist of an 18-gauge reinforcement strip on the front and back side of the base bottom. Each reinforcement strip is spot welded in place. Each strip consists of two 1/2" weld nuts on each end to except the caster or glide stem.

Casters or Glides

The unit can be specified with casters or glides. Casters or glides do not extend out from below the unit shell. Both caster and glides have 1/2" diameter threaded stud to mount to the bottom of the base and are interchangeable.

Casters:

All caster bodies are twin wheel hooded design with 2-3/4" diameter wheels. Two casters will have a lock and two will freely swivel. Casters will be black.

Glides:

All glides are 2-3/4" telescoping adjustable glides. Glides shall be made of two-piece construction. Both pieces shall be made of durable nylon. Each glide has a white base with a black body.

Hooks

Utility hooks are made of metal with a grey finish. Each hook is attached to the interior sides of the opening using two #10 tapping screws.

Doors

The doors are single wall construction with a structural hinge channel running the length of the door. Self-closing European style hinges with 110-degree opening, provide 3-way adjustment of door to ensure consistent gapping and operation. The steel door is standard with a lock and is specified with one of the lock options (see lock section below). If left or right designation is noted left or right specifies which side it is hinged on. All doors are inset.

Door Pulls

A door pull is only available when the **standard key lock** is chosen. One pull type is available.

Beveled pull: made from cast zinc. It mounts by use of 2 machine screws to a steel door. It is available in a brushed zinc or painted black finish.

Shelves

All fixed shelves are 3/4" thick with flanges, front and back, constructed of 22-gauge material. Each shelf is screw mounted in four places with # 10 screws into the outer panel and center panel to create separation between modules.

Locker - Open Units

Each open locker unit includes two hooks per opening.

Interior clearance:

36" high unit:
16-1/2" wide x 11-3/4" deep x 30-1/2" high
42" high unit:
16-1/2" wide x 11-3/4" deep x 36-1/2" high

Locker - With Doors

Each locker with door unit includes one locking door and 2 hooks in each section.

Interior clearance:

36" high unit:
16-1/2" wide x 10-7/8" deep x 30-1/2" high
42" high unit:
16-1/2" wide x 10-7/8" deep x 36-1/2" high

Cubbies

Each cubby unit includes two fixed shelves per section.

Interior clearance:

36" high unit:
16-1/2" wide x 10-7/8" deep x 9-5/8" high
42" high unit:
16-1/2" wide x 10-7/8" deep x 11-5/8" high

Cubbies - With Doors

Each cubby with door includes one locking door and two fixed shelves per section.

Interior clearance:

36" high unit:
16-1/2" wide x 10-7/8" deep x 9-5/8" high
42" high unit:
16-1/2" wide x 10-7/8" deep x 11-5/8" high

Bookshelves

Each bookshelf unit features two fixed shelves per section.

Interior clearance:

36" high unit:
34" wide x 10-7/8" deep x 9-5/8" high
42" high unit:
34" wide x 10-7/8" deep x 11-5/8" high

Locks

Locks are available anywhere a door is used, with four locking options for Ruckus Storage:

1. **Standard key lock** (comes with pull option only) - The standard lock is a high-security double-bit lock. The double-bit lock offers superior security when compared to a single-bit lock. Units are standard with random keys in a range of 994 different numbers. Specific keying combinations are available at no additional charge (this information must be included with order). Locks can be master keyed.

Please see the Accessories section of this price list for order information on master keys, extractor (core removal) keys, key blanks, cut keys, core sets and key sets. All standard locks have removable and interchangeable plugs. This feature allows

for onsite custom keying. Units can be supplied with lock plugs installed or shipped separately. To install or remove lock plugs, a unique key is required. This key is the extractor (core removal) key and can be found in the Accessories section. Contact KI Customer Service to order lock accessories. To order plugs for field installation, specify "lock plugs not installed" on order. Order must specify total quantity of specific key-number locks.

Example: 30 plugs
3 keyed alike
10 keyed alike
17 keyed alike

2. **Padlock** - Robust zinc housing allows the end user to apply their own combination lock. Lock is backed with a stainless steel escutcheon plate to protect the paint finish.
3. **Combination lock** - A 4-dial combination lock that allows user to access locker without the need of a key. All locks are shipped with a factory set code 3333, combination is set by the end user or facility manager. In the case of lost or forgotten codes, a master key override will unlock the unit and allow the lock to be recoded. Combination lock features solid zinc construction. And a four digit combination allows up to 10,000 unique codes.
4. **Digital lock** - Stand-alone battery operated lock allows user immediate and simple keypad access without the need of a key. All locks are shipped with a factory set code 2244, the new access code is set by the end user or facility manager. Users have the flexibility to set and change a personal entry code, while a preset master code ensures that supervisor access is always available, or in an emergency, the key code can be overridden.

Features:

- Up to 80,000 operating cycle's battery life
- Low battery warning
- Battery failure key override
- 8-digit master code and 6-digit sub-master codes
- 4-digit user code (10,000 unique codes)
- 6-digit technician code
- Code changeable
- Not suitable for chlorinated environments
- Can be programed for single use set at time of use or fixed combination mode

Finish

Units are offered in numerous powder-coat colors. Powder-coat application is a hybrid epoxy. Paint is baked on to provide a scratch and stain resistant finish. Shells and doors may be specified in separate colors for no upcharge. Mechanical components are plated or finished with other protective coatings.



Ruckus Storage

All steel design allows for greater durability and cleaning.

Door finish can be specified independently of shell to allow for greater brand identification.

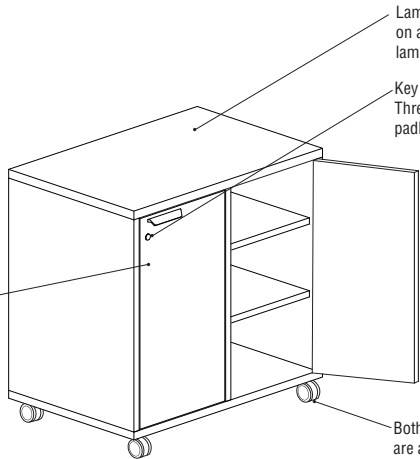

Laminate worksurfaces comes standard on all storage units. Available in all KI laminates.

Key locks come standard on doored storage. Three additional locks available, combination, padlock, and digital.

Both casters and glide options are available.

General Dimension			
A (Height)	B (Width)	C (Depth)	D (Door Pull to Door Pull)
36"	36-1/8" - 54-5/8"	24-3/8"	24.66"
42"	36-1/8" - 54-5/8"	24-3/8"	24.66"

Top View
(54" Cubbie with Doors shown)

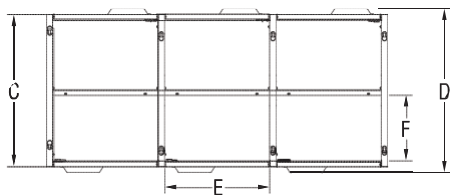

Front View
(54" Open Cubbie shown)

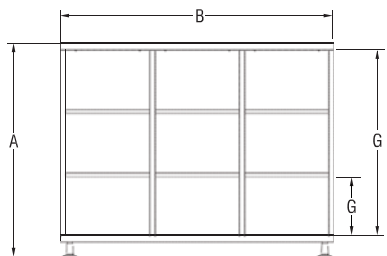

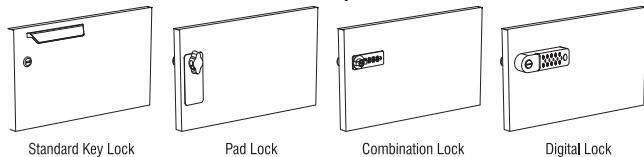

Interior Clearance per Storage Compartment			
Storage Height	E (Width)	F (Depth)	G (Height)
36" Open Locker	16-1/2"	11-3/4"	30-1/2"
42" Open Locker	16-1/2"	11-3/4"	36-1/2"
36" Locker w/Door	16-1/2"	10-7/8"	30-1/2"
42" Locker w/Door	16-1/2"	10-7/8"	36-1/2"
36" Open Cubbie	16-1/2"	10-7/8"	9-5/8"
42" Open Cubbie	16-1/2"	10-7/8"	11-5/8"
36" Cubbie w/Door	16-1/2"	10-7/8"	9-5/8"
42" Cubbie w/Door	16-1/2"	10-7/8"	11-5/8"
36" Bookshelf	34"	10-7/8"	9-5/8"
42" Bookshelf	34"	10-7/8"	11-5/8"

Lock Options



Ruckus™ Seating (Freight Excluded Pricing)

Four-Leg Chair

	MODEL	Features	H	MODEL NUMBER					
				Basic Model	Fire Code	Poly Color	Frame Color	Glide Option	Upholstery Color
	Four-Leg Chair with Glides • Model does not stack • Ships fully assembled, packaged 1 chair per carton	Polypropylene	15"	RK1100H15NB	<input type="checkbox"/> <input type="checkbox"/> <input type="checkbox"/>	<input type="checkbox"/> <input type="checkbox"/> <input type="checkbox"/>	<input type="checkbox"/> <input type="checkbox"/>	<input type="checkbox"/> <input type="checkbox"/> <input type="checkbox"/>	
		Polypropylene	18"	RK1100H18NB	<input type="checkbox"/> <input type="checkbox"/> <input type="checkbox"/>	<input type="checkbox"/> <input type="checkbox"/> <input type="checkbox"/>	<input type="checkbox"/> <input type="checkbox"/>	<input type="checkbox"/> <input type="checkbox"/> <input type="checkbox"/>	
RK11									
	Four-Leg Chair with Glides • Model does not stack • Ships fully assembled, packaged 1 chair per carton	Upholstered Seat	15"	RK1200H15NB	<input type="checkbox"/> <input type="checkbox"/> <input type="checkbox"/>	<input type="checkbox"/> <input type="checkbox"/> <input type="checkbox"/>	<input type="checkbox"/> <input type="checkbox"/>	<input type="checkbox"/> <input type="checkbox"/> <input type="checkbox"/>	<input type="checkbox"/> <input type="checkbox"/> <input type="checkbox"/> <input type="checkbox"/>
		Upholstered Seat	18"	RK1200H18NB	<input type="checkbox"/> <input type="checkbox"/> <input type="checkbox"/>	<input type="checkbox"/> <input type="checkbox"/> <input type="checkbox"/>	<input type="checkbox"/> <input type="checkbox"/>	<input type="checkbox"/> <input type="checkbox"/> <input type="checkbox"/>	<input type="checkbox"/> <input type="checkbox"/> <input type="checkbox"/> <input type="checkbox"/>
RK12									

A **B** **C** **D** **E** **F**

HOW TO ORDER

Indicate the following information on order form:

- Quantity of each item.
- Model number, including options. See "How To Build a Model Number".
- Any special service required.

Note: • The indicates that a choice is required.

- The absence of the indicates that no choice is required.
- Alpha-numeric characters in place of indicate that no other alternatives are available.

HOW TO BUILD A MODEL NUMBER

- A** Select basic model.
- B** Select fire retardant.

NFR	- Compliance to TB 117-2013
FR	- Compliance to TB 133
- C** Select poly color. Refer to color addendum at ki.com or KI Fabrics & Finishes binder.
- D** Select frame finish. Refer to color addendum at ki.com or KI Fabrics & Finishes binder.
- E** Select glide option.

GFT	- Felt glides
GPL	- Nylon plastic glides
GSL	- Steel glides
- F** Select upholstery grade/color. Refer to color addendum at ki.com or KI Fabrics & Finishes binder.



Ruckus™ Seating (Freight Excluded Pricing)

Four-Leg Chair

Approx. Packaged Weight	Freight Excluded Pricing Unupholstered	Freight Excluded Pricing Fabric Grade 1 & C.O.M.	Freight Excluded Pricing Fabric Grade 2	Freight Excluded Pricing Fabric Grade 3 & Group 2V Vinyl	Freight Excluded Pricing C.O.V.	Freight Excluded Pricing Pallas Fabric Group P0	Freight Excluded Pricing Pallas Fabric Group P1	Freight Excluded Pricing Pallas Fabric Group P2	Freight Excluded Pricing Pallas Fabric Group P3	Freight Excluded Pricing Pallas Fabric Group P4
29.0#	\$ 159									
30.0#	161									
31.5#	N/A	\$ 251	\$ 259	\$ 274	\$ 251	\$ 282	\$ 328	\$ 342	\$ 360	\$ 386
32.5#	N/A	253	261	276	253	284	330	344	362	388

UPHOLSTERY INFORMATION

C.O.M. Upholstery

C.O.M. requirement for 10 chairs or less with upholstered seat or upholstered seat and back is 3/4 yard per chair of 54" wide nondirectional fabric. For orders of 11 or more with upholstered seat and back and for complete information on ordering C.O.M. see "Ordering C.O.M., C.O.V. and C.O.L." section.

OPTIONS

California TB133 Fire Safety Code

The above seating products can be manufactured using the appropriate flame-retardant materials for compliance to California Technical Bulletin 133. Add "FR" to end of model number.
 Model=Polypropylene
 Added Lead Time=none
 Added List Price=\$19
 Model=Upholstered Seat Only
 Added Lead Time=none
 Added List Price=\$30

SPECIAL SERVICES

Special Carton Marking

With specially marked information N/C



Shipping

Shipped **assembled f.o.b. Green Bay, Wisconsin 54302** factory. Freight class #125.

Specifications and prices are subject to change without prior notice.

Ruckus™ Seating (Freight Excluded Pricing)

Four-Leg Chair

	MODEL	Features	H	MODEL NUMBER					
				Basic Model	Fire Code	Poly Color	Frame Color	Caster Type	Upholstery Color
 <p>RK21</p>	Four-Leg Chair with Casters • Model does not stack • Ships fully assembled, packaged 1 chair per carton	Polypropylene	15"	RK2100H15NB	<input type="checkbox"/> <input type="checkbox"/> <input type="checkbox"/>	<input type="checkbox"/> <input type="checkbox"/> <input type="checkbox"/>	<input type="checkbox"/> <input type="checkbox"/>	<input type="checkbox"/> <input type="checkbox"/> <input type="checkbox"/>	
		Polypropylene	18"	RK2100H18NB	<input type="checkbox"/> <input type="checkbox"/> <input type="checkbox"/>	<input type="checkbox"/> <input type="checkbox"/> <input type="checkbox"/>	<input type="checkbox"/> <input type="checkbox"/>	<input type="checkbox"/> <input type="checkbox"/> <input type="checkbox"/>	
 <p>RK22</p>	Four-Leg Chair with Casters • Model does not stack • Ships fully assembled, packaged 1 chair per carton	Upholstered Seat	15"	RK2200H15NB	<input type="checkbox"/> <input type="checkbox"/> <input type="checkbox"/>	<input type="checkbox"/> <input type="checkbox"/> <input type="checkbox"/>	<input type="checkbox"/> <input type="checkbox"/>	<input type="checkbox"/> <input type="checkbox"/> <input type="checkbox"/> <input type="checkbox"/>	
		Upholstered Seat	18"	RK2200H18NB	<input type="checkbox"/> <input type="checkbox"/> <input type="checkbox"/>	<input type="checkbox"/> <input type="checkbox"/> <input type="checkbox"/>	<input type="checkbox"/> <input type="checkbox"/>	<input type="checkbox"/> <input type="checkbox"/> <input type="checkbox"/> <input type="checkbox"/>	

A **B** **C** **D** **E** **F**

HOW TO ORDER

Indicate the following information on order form:

1. Quantity of each item.
2. Model number, including options. See "How To Build a Model Number".
3. Any special service required.

Note:

- The indicates that a choice is required.
- The absence of the indicates that no choice is required.
- Alpha-numeric characters in place of indicate that no other alternatives are available.

HOW TO BUILD A MODEL NUMBER

- A** Select basic model.
- B** Select fire retardant.

NFR	- Compliance to TB 117-2013
FR	- Compliance to TB 133
- C** Select poly color. Refer to color addendum at ki.com or KI Fabrics & Finishes binder.
- D** Select frame finish. Refer to color addendum at ki.com or KI Fabrics & Finishes binder.
- E** Select caster type.

CCC	- Carpet casters
CHC	- Hard floor casters
- F** Select upholstery grade/color. Refer to color addendum at ki.com or KI Fabrics & Finishes binder.



Ruckus™ Seating (Freight Excluded Pricing)

Four-Leg Chair

Approx. Packaged Weight	Freight Excluded Pricing Unupholstered	Freight Excluded Pricing Fabric Grade 1 & C.O.M.	Freight Excluded Pricing Fabric Grade 2	Freight Excluded Pricing Fabric Grade 3 & Group 2V Vinyl	Freight Excluded Pricing C.O.V.	Freight Excluded Pricing Pallas Fabric Group P0	Freight Excluded Pricing Pallas Fabric Group P1	Freight Excluded Pricing Pallas Fabric Group P2	Freight Excluded Pricing Pallas Fabric Group P3	Freight Excluded Pricing Pallas Fabric Group P4
29.5#	\$ 170									
30.5#	172									
32.0#	N/A	\$ 262	\$ 270	\$ 285	\$ 262	\$ 293	\$ 339	\$ 353	\$ 371	\$ 397
33.0#	N/A	264	272	287	264	295	341	355	373	399

UPHOLSTERY INFORMATION

C.O.M. Upholstery

C.O.M. requirement for 10 chairs or less with upholstered seat or upholstered seat and back is 3/4 yard per chair of 54" wide nondirectional fabric. For orders of 11 or more with upholstered seat and back and for complete information on ordering C.O.M. see "Ordering C.O.M., C.O.V. and C.O.L." section.

OPTIONS

California TB133 Fire Safety Code

The above seating products can be manufactured using the appropriate flame-retardant materials for compliance to California Technical Bulletin 133. Add "FR" to end of model number.
 Model=Polypropylene
 Added Lead Time=none
 Added List Price=\$19
 Model=Upholstered Seat Only
 Added Lead Time=none
 Added List Price=\$30

SPECIAL SERVICES

Special Carton Marking

With specially marked information N/C



Shipping

Shipped **assembled f.o.b. Green Bay, Wisconsin 54302** factory. Freight class #125.

Specifications and prices are subject to change without prior notice.

Ruckus™ Seating (Freight Excluded Pricing)

Stack Chair with Glides

	MODEL	Features	H	MODEL NUMBER					
				Basic Model	Fire Code	Poly Color	Frame Color	Glide Option	Upholstery Color
 RKU1	Stack Chair with Glides • Ships fully assembled, packaged 2 chairs per carton • 15" chair stacks 3 high • 18" chair stacks 4 high	Polypropylene	15"	RKU100H15NB	<input type="checkbox"/> <input type="checkbox"/> <input type="checkbox"/>	<input type="checkbox"/> <input type="checkbox"/> <input type="checkbox"/>	<input type="checkbox"/> <input type="checkbox"/>	<input type="checkbox"/> <input type="checkbox"/> <input type="checkbox"/>	
		Polypropylene	18"	RKU100H18NB	<input type="checkbox"/> <input type="checkbox"/> <input type="checkbox"/>	<input type="checkbox"/> <input type="checkbox"/> <input type="checkbox"/>	<input type="checkbox"/> <input type="checkbox"/>	<input type="checkbox"/> <input type="checkbox"/> <input type="checkbox"/>	
 RKU2	Stack Chair with Glides • Ships fully assembled, packaged 1 chair per carton • 15" chair stacks 2 high • 18" chair stacks 3 high	Upholstered Seat	15"	RKU200H15NB	<input type="checkbox"/> <input type="checkbox"/> <input type="checkbox"/>	<input type="checkbox"/> <input type="checkbox"/> <input type="checkbox"/>	<input type="checkbox"/> <input type="checkbox"/>	<input type="checkbox"/> <input type="checkbox"/> <input type="checkbox"/>	<input type="checkbox"/> <input type="checkbox"/> <input type="checkbox"/> <input type="checkbox"/>
		Upholstered Seat	18"	RKU200H18NB	<input type="checkbox"/> <input type="checkbox"/> <input type="checkbox"/>	<input type="checkbox"/> <input type="checkbox"/> <input type="checkbox"/>	<input type="checkbox"/> <input type="checkbox"/>	<input type="checkbox"/> <input type="checkbox"/> <input type="checkbox"/>	<input type="checkbox"/> <input type="checkbox"/> <input type="checkbox"/> <input type="checkbox"/>

A **B** **C** **D** **E** **F**

HOW TO ORDER

Indicate the following information on order form:

- Quantity of each item.
- Model number, including options. See "How To Build a Model Number".
- Any special service required.

Note: • The indicates that a choice is required.

- The absence of the indicates that no choice is required.
- Alpha-numeric characters in place of indicate that no other alternatives are available.

HOW TO BUILD A MODEL NUMBER

- A** Select basic model.
- B** Select fire retardant.

NFR	- Compliance to TB 117-2013
FR	- Compliance to TB 133
- C** Select poly color. Refer to color addendum at ki.com or KI Fabrics & Finishes binder.
- D** Select frame finish. Refer to color addendum at ki.com or KI Fabrics & Finishes binder.
- E** Select glide option.

GFT	- Felt glides
GPL	- Nylon plastic glides
GSL	- Steel glides
- F** Select upholstery grade/color. Refer to color addendum at ki.com or KI Fabrics & Finishes binder.



Ruckus™ Seating (Freight Excluded Pricing)

Stack Chair with Glides

Approx. Packaged Weight	Freight Excluded Pricing Unupholstered	Freight Excluded Pricing Fabric Grade 1 & C.O.M.	Freight Excluded Pricing Fabric Grade 2	Freight Excluded Pricing Fabric Grade 3 & Group 2V Vinyl	Freight Excluded Pricing C.O.V.	Freight Excluded Pricing Pallas Fabric Group P0	Freight Excluded Pricing Pallas Fabric Group P1	Freight Excluded Pricing Pallas Fabric Group P2	Freight Excluded Pricing Pallas Fabric Group P3	Freight Excluded Pricing Pallas Fabric Group P4
34.0#	\$ 215									
35.0#	218									
36.5#	N/A	\$ 307	\$ 315	\$ 330	\$ 307	\$ 338	\$ 384	\$ 398	\$ 416	\$ 442
37.5#	N/A	310	318	333	310	341	387	401	419	445

UPHOLSTERY INFORMATION

C.O.M. Upholstery

C.O.M. requirement for 10 chairs or less with upholstered seat or upholstered seat and back is 3/4 yard per chair of 54" wide nondirectional fabric. For orders of 11 or more with upholstered seat and back and for complete information on ordering C.O.M. see "Ordering C.O.M., C.O.V. and C.O.L." section.

OPTIONS

California TB133 Fire Safety Code

The above seating products can be manufactured using the appropriate flame-retardant materials for compliance to California Technical Bulletin 133. Add "FR" to end of model number.
 Model=Polypropylene
 Added Lead Time=none
 Added List Price=\$19
 Model=Upholstered Seat Only
 Added Lead Time=none
 Added List Price=\$30

SPECIAL SERVICES

Special Carton Marking

With specially marked information N/C



Shipping

Shipped **assembled f.o.b. Green Bay, Wisconsin 54302** factory. Freight class #125.

Specifications and prices are subject to change without prior notice.

Ruckus™ Seating (Freight Excluded Pricing)

Stack Chair with Glides

	MODEL	Features	H	MODEL NUMBER						
				Basic Model	Fire Code	Poly Color	Frame Color	Bookrack Color	Glide Option	Upholstery Color
 <p>RKU1</p>	Stack Chair with Glides and Bookrack	Polypropylene	15"	RKU100H15BR	<input type="checkbox"/> <input type="checkbox"/> <input type="checkbox"/>	<input type="checkbox"/> <input type="checkbox"/> <input type="checkbox"/>	<input type="checkbox"/> <input type="checkbox"/>	<input type="checkbox"/> <input type="checkbox"/> <input type="checkbox"/> <input type="checkbox"/>	<input type="checkbox"/> <input type="checkbox"/> <input type="checkbox"/>	
		• Ships fully assembled, packaged 2 chairs per carton	Polypropylene	18"	RKU100H18BR	<input type="checkbox"/> <input type="checkbox"/> <input type="checkbox"/>	<input type="checkbox"/> <input type="checkbox"/> <input type="checkbox"/>	<input type="checkbox"/> <input type="checkbox"/>	<input type="checkbox"/> <input type="checkbox"/> <input type="checkbox"/> <input type="checkbox"/>	<input type="checkbox"/> <input type="checkbox"/> <input type="checkbox"/>
	• 15" chair stacks 3 high									
	• 18" chair stacks 4 high									
 <p>RKU2</p>	Stack Chair with Glides and Bookrack	Upholstered Seat	15"	RKU200H15BR	<input type="checkbox"/> <input type="checkbox"/> <input type="checkbox"/>	<input type="checkbox"/> <input type="checkbox"/> <input type="checkbox"/>	<input type="checkbox"/> <input type="checkbox"/>	<input type="checkbox"/> <input type="checkbox"/> <input type="checkbox"/> <input type="checkbox"/>	<input type="checkbox"/> <input type="checkbox"/> <input type="checkbox"/>	<input type="checkbox"/> <input type="checkbox"/> <input type="checkbox"/> <input type="checkbox"/>
		• Ships fully assembled, packaged 1 chair per carton	Upholstered Seat	18"	RKU200H18BR	<input type="checkbox"/> <input type="checkbox"/> <input type="checkbox"/>	<input type="checkbox"/> <input type="checkbox"/> <input type="checkbox"/>	<input type="checkbox"/> <input type="checkbox"/>	<input type="checkbox"/> <input type="checkbox"/> <input type="checkbox"/> <input type="checkbox"/>	<input type="checkbox"/> <input type="checkbox"/> <input type="checkbox"/>
	• 15" chair stacks 2 high									
	• 18" chair stacks 3 high									

A **B** **C** **D** **E** **F** **G**

HOW TO ORDER

Indicate the following information on order form:

- Quantity of each item.
- Model number, including options. See "How To Build a Model Number".
- Any special service required.

Note: • The indicates that a choice is required.

- The absence of the indicates that no choice is required.
- Alpha-numeric characters in place of indicate that no other alternatives are available.

HOW TO BUILD A MODEL NUMBER

- A** Select basic model.

NFR	- Compliance to TB 117-2013
FR	- Compliance to TB 133
- B** Select fire retardant.

NFR	- Compliance to TB 117-2013
FR	- Compliance to TB 133
- C** Select poly color.
Refer to color addendum at ki.com or KI Fabrics & Finishes binder.
- D** Select frame finish.
Refer to color addendum at ki.com or KI Fabrics & Finishes binder.
- E** Select bookrack color.
Refer to color addendum at ki.com or KI Fabrics & Finishes binder.
- F** Select glide option.

GFT	- Felt glides
GPL	- Nylon plastic glides
GSL	- Steel glides

- G** Select upholstery grade/color.
Refer to color addendum at ki.com or KI Fabrics & Finishes binder.



Ruckus™ Seating (Freight Excluded Pricing)

Stack Chair with Glides

Approx. Packaged Weight	Freight Excluded Pricing Unupholstered	Freight Excluded Pricing Fabric Grade 1 & C.O.M.	Freight Excluded Pricing Fabric Grade 2	Freight Excluded Pricing Fabric Grade 3 & Group 2V Vinyl	Freight Excluded Pricing C.O.V.	Freight Excluded Pricing Pallas Fabric Group P0	Freight Excluded Pricing Pallas Fabric Group P1	Freight Excluded Pricing Pallas Fabric Group P2	Freight Excluded Pricing Pallas Fabric Group P3	Freight Excluded Pricing Pallas Fabric Group P4
37.0#	\$ 262									
38.0#	265									
39.5#	N/A	\$ 354	\$ 362	\$ 377	\$ 354	\$ 385	\$ 431	\$ 445	\$ 463	\$ 489
40.5#	N/A	357	365	380	357	388	434	448	466	492

UPHOLSTERY INFORMATION

C.O.M. Upholstery

C.O.M. requirement for 10 chairs or less with upholstered seat or upholstered seat and back is 3/4 yard per chair of 54" wide nondirectional fabric. For orders of 11 or more with upholstered seat and back and for complete information on ordering C.O.M. see "Ordering C.O.M., C.O.V. and C.O.L." section.

OPTIONS

California TB133 Fire Safety Code

The above seating products can be manufactured using the appropriate flame-retardant materials for compliance to California Technical Bulletin 133. Add "FR" to end of model number.
 Model=Polypropylene
 Added Lead Time=none
 Added List Price=\$19
 Model=Upholstered Seat Only
 Added Lead Time=none
 Added List Price=\$30

SPECIAL SERVICES

Special Carton Marking

With specially marked information N/C



Shipping

Shipped assembled f.o.b. Green Bay, Wisconsin 54302 factory. Freight class #125.

Specifications and prices are subject to change without prior notice.

Ruckus™ Seating (Freight Excluded Pricing)

Stack Chair with Casters

	MODEL	Features	H	MODEL NUMBER					
				Basic Model	Fire Code	Poly Color	Frame Color	Caster Type	Upholstery Color
	Stack Chair with Casters	Polypropylene	15"	RKV100H15NB	<input type="checkbox"/> <input type="checkbox"/> <input type="checkbox"/>	<input type="checkbox"/> <input type="checkbox"/> <input type="checkbox"/>	<input type="checkbox"/> <input type="checkbox"/>	<input type="checkbox"/> <input type="checkbox"/> <input type="checkbox"/>	
	<ul style="list-style-type: none"> Ships fully assembled, packaged 2 chairs per carton 15" chair stacks 3 high 18" chair stacks 4 high 	Polypropylene	18"	RKV100H18NB	<input type="checkbox"/> <input type="checkbox"/> <input type="checkbox"/>	<input type="checkbox"/> <input type="checkbox"/> <input type="checkbox"/>	<input type="checkbox"/> <input type="checkbox"/>	<input type="checkbox"/> <input type="checkbox"/> <input type="checkbox"/>	
RKV1									
	Stack Chair with Casters	Upholstered Seat	15"	RKV200H15NB	<input type="checkbox"/> <input type="checkbox"/> <input type="checkbox"/>	<input type="checkbox"/> <input type="checkbox"/> <input type="checkbox"/>	<input type="checkbox"/> <input type="checkbox"/>	<input type="checkbox"/> <input type="checkbox"/> <input type="checkbox"/>	<input type="checkbox"/> <input type="checkbox"/> <input type="checkbox"/> <input type="checkbox"/>
	<ul style="list-style-type: none"> Ships fully assembled, packaged 1 chair per carton 15" chair stacks 2 high 18" chair stacks 3 high 	Upholstered Seat	18"	RKV200H18NB	<input type="checkbox"/> <input type="checkbox"/> <input type="checkbox"/>	<input type="checkbox"/> <input type="checkbox"/> <input type="checkbox"/>	<input type="checkbox"/> <input type="checkbox"/>	<input type="checkbox"/> <input type="checkbox"/> <input type="checkbox"/>	<input type="checkbox"/> <input type="checkbox"/> <input type="checkbox"/> <input type="checkbox"/>
RKV2									

A **B** **C** **D** **E** **F**

HOW TO ORDER

Indicate the following information on order form:

- Quantity of each item.
- Model number, including options. See "How To Build a Model Number".
- Any special service required.

Note: • The indicates that a choice is required.

- The absence of the indicates that no choice is required.
- Alpha-numeric characters in place of indicate that no other alternatives are available.

HOW TO BUILD A MODEL NUMBER

- A** Select basic model.
- B** Select fire retardant.

NFR	- Compliance to TB 117-2013
FR	- Compliance to TB 133
- C** Select poly color. Refer to color addendum at ki.com or KI Fabrics & Finishes binder.
- D** Select frame finish. Refer to color addendum at ki.com or KI Fabrics & Finishes binder.
- E** Select caster type.

CHC	- Hard floor casters
CCC	- Carpet casters
- F** Select upholstery grade/color. Refer to color addendum at ki.com or KI Fabrics & Finishes binder.



Ruckus™ Seating (Freight Excluded Pricing)

Stack Chair with Casters

Approx. Packaged Weight	Freight Excluded Pricing Unupholstered	Freight Excluded Pricing Fabric Grade 1 & C.O.M.	Freight Excluded Pricing Fabric Grade 2	Freight Excluded Pricing Fabric Grade 3 & Group 2V Vinyl	Freight Excluded Pricing C.O.V.	Freight Excluded Pricing Pallas Fabric Group P0	Freight Excluded Pricing Pallas Fabric Group P1	Freight Excluded Pricing Pallas Fabric Group P2	Freight Excluded Pricing Pallas Fabric Group P3	Freight Excluded Pricing Pallas Fabric Group P4
34.5#	\$ 226									
35.5#	229									
37.0#	N/A	\$ 318	\$ 326	\$ 341	\$ 318	\$ 349	\$ 395	\$ 409	\$ 427	\$ 453
38.0#	N/A	321	329	344	321	352	398	412	430	456

UPHOLSTERY INFORMATION

C.O.M. Upholstery

C.O.M. requirement for 10 chairs or less with upholstered seat or upholstered seat and back is 3/4 yard per chair of 54" wide nondirectional fabric. For orders of 11 or more with upholstered seat and back and for complete information on ordering C.O.M. see "Ordering C.O.M., C.O.V. and C.O.L." section.

OPTIONS

California TB133 Fire Safety Code

The above seating products can be manufactured using the appropriate flame-retardant materials for compliance to California Technical Bulletin 133. Add "FR" to end of model number.
 Model=Polypropylene
 Added Lead Time=none
 Added List Price=\$19
 Model=Upholstered Seat Only
 Added Lead Time=none
 Added List Price=\$30

SPECIAL SERVICES

Special Carton Marking

With specially marked information N/C



Shipping

Shipped **assembled f.o.b. Green Bay, Wisconsin 54302** factory. Freight class #125.

Specifications and prices are subject to change without prior notice.

Ruckus™ Seating (Freight Excluded Pricing)

Stack Chair with Casters

	MODEL	Features	H	MODEL NUMBER						
				Basic Model	Fire Code	Poly Color	Frame Color	Bookrack Color	Caster Type	Upholstery Color
 <p>RKV1</p>	Stack Chair with Casters and Bookrack • Ships fully assembled, packaged 2 chairs per carton • 15" chair stacks 3 high • 18" chair stacks 4 high	Polypropylene	15"	RKV100H15BR	<input type="checkbox"/> <input type="checkbox"/> <input type="checkbox"/>	<input type="checkbox"/> <input type="checkbox"/> <input type="checkbox"/>	<input type="checkbox"/> <input type="checkbox"/>	<input type="checkbox"/> <input type="checkbox"/> <input type="checkbox"/> <input type="checkbox"/>	<input type="checkbox"/> <input type="checkbox"/>	
		Polypropylene	18"	RKV100H18BR	<input type="checkbox"/> <input type="checkbox"/> <input type="checkbox"/>	<input type="checkbox"/> <input type="checkbox"/> <input type="checkbox"/>	<input type="checkbox"/> <input type="checkbox"/>	<input type="checkbox"/> <input type="checkbox"/> <input type="checkbox"/> <input type="checkbox"/>	<input type="checkbox"/> <input type="checkbox"/>	
 <p>RKV2</p>	Stack Chair with Casters and Bookrack • Ships fully assembled, packaged 1 chair per carton • 15" chair stacks 2 high • 18" chair stacks 3 high	Upholstered Seat	15"	RKV200H15BR	<input type="checkbox"/> <input type="checkbox"/> <input type="checkbox"/>	<input type="checkbox"/> <input type="checkbox"/> <input type="checkbox"/>	<input type="checkbox"/> <input type="checkbox"/>	<input type="checkbox"/> <input type="checkbox"/> <input type="checkbox"/> <input type="checkbox"/>	<input type="checkbox"/> <input type="checkbox"/>	<input type="checkbox"/> <input type="checkbox"/> <input type="checkbox"/> <input type="checkbox"/>
		Upholstered Seat	18"	RKV200H18BR	<input type="checkbox"/> <input type="checkbox"/> <input type="checkbox"/>	<input type="checkbox"/> <input type="checkbox"/> <input type="checkbox"/>	<input type="checkbox"/> <input type="checkbox"/>	<input type="checkbox"/> <input type="checkbox"/> <input type="checkbox"/> <input type="checkbox"/>	<input type="checkbox"/> <input type="checkbox"/>	<input type="checkbox"/> <input type="checkbox"/> <input type="checkbox"/> <input type="checkbox"/>

A **B** **C** **D** **E** **F** **G**

HOW TO ORDER

Indicate the following information on order form:

- Quantity of each item.
- Model number, including options. See "How To Build a Model Number".
- Any special service required.

Note: • The indicates that a choice is required.

- The absence of the indicates that no choice is required.
- Alpha-numeric characters in place of indicate that no other alternatives are available.

HOW TO BUILD A MODEL NUMBER

Refer to color addendum at ki.com or KI Fabrics & Finishes binder.

- A** Select basic model.
- B** Select fire retardant.

NFR	- Compliance to TB 117-2013
FR	- Compliance to TB 133
- C** Select poly color.
Refer to color addendum at ki.com or KI Fabrics & Finishes binder.
- D** Select frame finish.
Refer to color addendum at ki.com or KI Fabrics & Finishes binder.
- E** Select bookrack color.
Refer to color addendum at ki.com or KI Fabrics & Finishes binder.
- F** Select caster type.

CHC	- Hard floor casters
CCC	- Carpet casters
- G** Select upholstery grade/color.



Ruckus™ Seating (Freight Excluded Pricing)

Stack Chair with Casters

Approx. Packaged Weight	Freight Excluded Pricing Unupholstered	Freight Excluded Pricing Fabric Grade 1 & C.O.M.	Freight Excluded Pricing Fabric Grade 2	Freight Excluded Pricing Fabric Grade 3 & Group 2V Vinyl	Freight Excluded Pricing C.O.V.	Freight Excluded Pricing Pallas Fabric Group P0	Freight Excluded Pricing Pallas Fabric Group P1	Freight Excluded Pricing Pallas Fabric Group P2	Freight Excluded Pricing Pallas Fabric Group P3	Freight Excluded Pricing Pallas Fabric Group P4
37.5#	\$ 273									
38.5#	276									
40.0#	N/A	\$ 365	\$ 373	\$ 388	\$ 365	\$ 396	\$ 442	\$ 456	\$ 474	\$ 500
41.0#	N/A	368	376	391	368	399	445	459	477	503

UPHOLSTERY INFORMATION

C.O.M. Upholstery

C.O.M. requirement for 10 chairs or less with upholstered seat or upholstered seat and back is 3/4 yard per chair of 54" wide nondirectional fabric. For orders of 11 or more with upholstered seat and back and for complete information on ordering C.O.M. see "Ordering C.O.M., C.O.V. and C.O.L." section.

OPTIONS

California TB133 Fire Safety Code

The above seating products can be manufactured using the appropriate flame-retardant materials for compliance to California Technical Bulletin 133. Add "FR" to end of model number.
 Model=Polypropylene
 Added Lead Time=none
 Added List Price=\$19
 Model=Upholstered Seat Only
 Added Lead Time=none
 Added List Price=\$30

SPECIAL SERVICES

Special Carton Marking

With specially marked information N/C



Shipping

Shipped assembled f.o.b. Green Bay, Wisconsin 54302 factory. Freight class #125.

Specifications and prices are subject to change without prior notice.

Ruckus™ Seating (Freight Excluded Pricing)

Stools

				MODEL NUMBER					
MODEL	Features	H	Basic Model	Fire Code	Poly Color	Frame Color	Glide Option	Upholstery Color	
	Stool No Bookrack • Casters not available on stool models • Ships fully assembled, packaged 1 chair per carton • Stacks 3 high	Polypropylene 24"	RK4100H24NB	<input type="checkbox"/> <input type="checkbox"/>	<input type="checkbox"/> <input type="checkbox"/>	<input type="checkbox"/>	<input type="checkbox"/> <input type="checkbox"/>		
		Polypropylene 30"	RK4100H30NB	<input type="checkbox"/> <input type="checkbox"/>	<input type="checkbox"/> <input type="checkbox"/>	<input type="checkbox"/>	<input type="checkbox"/> <input type="checkbox"/>		
	Stool No Bookrack • Casters not available on stool models • Ships fully assembled, packaged 1 chair per carton • Stacks 3 high	Upholstered Seat 24"	RK4200H24NB	<input type="checkbox"/> <input type="checkbox"/>	<input type="checkbox"/> <input type="checkbox"/>	<input type="checkbox"/>	<input type="checkbox"/> <input type="checkbox"/>	<input type="checkbox"/> <input type="checkbox"/> <input type="checkbox"/> <input type="checkbox"/>	
		Upholstered Seat 30"	RK4200H30NB	<input type="checkbox"/> <input type="checkbox"/>	<input type="checkbox"/> <input type="checkbox"/>	<input type="checkbox"/>	<input type="checkbox"/> <input type="checkbox"/>	<input type="checkbox"/> <input type="checkbox"/> <input type="checkbox"/> <input type="checkbox"/>	

RK41

RK42

A **B** **C** **D** **E** **F**

HOW TO ORDER

Indicate the following information on order form:

- Quantity of each item.
- Model number, including options. See "How To Build a Model Number".
- Any special service required.

Note: • The indicates that a choice is required.

- The absence of the indicates that no choice is required.
- Alpha-numeric characters in place of indicate that no other alternatives are available.

HOW TO BUILD A MODEL NUMBER

- A** Select basic model.
- B** Select fire retardant.

NFR	- Compliance to TB 117-2013
FR	- Compliance to TB 133
- C** Select poly color. Refer to color addendum at ki.com or KI Fabrics & Finishes binder.
- D** Select frame finish. Refer to color addendum at ki.com or KI Fabrics & Finishes binder.
- E** Select glide option.

GFT	- Felt glides
GPL	- Nylon plastic glides
GSL	- Steel glides
- F** Select upholstery grade/color. Refer to color addendum at ki.com or KI Fabrics & Finishes binder.



Ruckus™ Seating (Freight Excluded Pricing)

Stools

Approx. Packaged Weight	Freight Excluded Pricing Unupholstered	Freight Excluded Pricing Fabric Grade 1 & C.O.M.	Freight Excluded Pricing Fabric Grade 2	Freight Excluded Pricing Fabric Grade 3 & Group 2V Vinyl	Freight Excluded Pricing C.O.V.	Freight Excluded Pricing Pallas Fabric Group P0	Freight Excluded Pricing Pallas Fabric Group P1	Freight Excluded Pricing Pallas Fabric Group P2	Freight Excluded Pricing Pallas Fabric Group P3	Freight Excluded Pricing Pallas Fabric Group P4
42.0#	\$ 256									
43.0#	265									
44.5#	N/A	\$ 348	\$ 356	\$ 371	\$ 348	\$ 379	\$ 425	\$ 439	\$ 457	\$ 483
45.5#	N/A	357	365	380	357	388	435	448	466	492

UPHOLSTERY INFORMATION

C.O.M. Upholstery

C.O.M. requirement for 10 chairs or less with upholstered seat or upholstered seat and back is 3/4 yard per chair of 54" wide nondirectional fabric. For orders of 11 or more with upholstered seat and back and for complete information on ordering C.O.M. see "Ordering C.O.M., C.O.V. and C.O.L." section.

OPTIONS

California TB133 Fire Safety Code

The above seating products can be manufactured using the appropriate flame-retardant materials for compliance to California Technical Bulletin 133. Add "FR" to end of model number.
 Model=Polypropylene
 Added Lead Time=none
 Added List Price=\$19
 Model=Upholstered Seat Only
 Added Lead Time=none
 Added List Price=\$30

SPECIAL SERVICES

Special Carton Marking

With specially marked information N/C



Shipping

Shipped assembled f.o.b. Green Bay, Wisconsin 54302 factory. Freight class #125.

Specifications and prices are subject to change without prior notice.

Ruckus™ Seating (Freight Excluded Pricing)

Stools

				MODEL NUMBER							
MODEL	Features	H	Basic Model	Fire Code	Poly Color	Frame Color	Bookrack Color	Glide Option	Upholstery Color		
	Stool with Bookrack • Casters not available on stool models • Ships fully assembled, packaged 1 chair per carton • Stacks 3 high	Polypropylene 24"	RK4100H24BR	<input type="checkbox"/> <input type="checkbox"/> <input type="checkbox"/>	<input type="checkbox"/> <input type="checkbox"/> <input type="checkbox"/>	<input type="checkbox"/>	<input type="checkbox"/> <input type="checkbox"/> <input type="checkbox"/> <input type="checkbox"/>	<input type="checkbox"/> <input type="checkbox"/> <input type="checkbox"/>			
		Polypropylene 30"	RK4100H30BR	<input type="checkbox"/> <input type="checkbox"/> <input type="checkbox"/>	<input type="checkbox"/> <input type="checkbox"/> <input type="checkbox"/>	<input type="checkbox"/>	<input type="checkbox"/> <input type="checkbox"/> <input type="checkbox"/> <input type="checkbox"/>	<input type="checkbox"/> <input type="checkbox"/> <input type="checkbox"/>			
	Stool with Bookrack • Casters not available on stool models • Ships fully assembled, packaged 1 chair per carton • Stacks 3 high	Upholstered Seat 24"	RK4200H24BR	<input type="checkbox"/> <input type="checkbox"/> <input type="checkbox"/>	<input type="checkbox"/> <input type="checkbox"/> <input type="checkbox"/>	<input type="checkbox"/>	<input type="checkbox"/> <input type="checkbox"/> <input type="checkbox"/> <input type="checkbox"/>	<input type="checkbox"/> <input type="checkbox"/> <input type="checkbox"/>	<input type="checkbox"/> <input type="checkbox"/> <input type="checkbox"/> <input type="checkbox"/>		
		Upholstered Seat 30"	RK4200H30BR	<input type="checkbox"/> <input type="checkbox"/> <input type="checkbox"/>	<input type="checkbox"/> <input type="checkbox"/> <input type="checkbox"/>	<input type="checkbox"/>	<input type="checkbox"/> <input type="checkbox"/> <input type="checkbox"/> <input type="checkbox"/>	<input type="checkbox"/> <input type="checkbox"/> <input type="checkbox"/>	<input type="checkbox"/> <input type="checkbox"/> <input type="checkbox"/> <input type="checkbox"/>		

RK41

RK42

A **B** **C** **D** **E** **F** **G**

HOW TO ORDER

Indicate the following information on order form:

- Quantity of each item.
- Model number, including options. See "How To Build a Model Number".
- Any special service required.

Note: • The indicates that a choice is required.

- The absence of the indicates that no choice is required.
- Alpha-numeric characters in place of indicate that no other alternatives are available.

HOW TO BUILD A MODEL NUMBER

- A** Select basic model.
- B** Select fire retardant.
 - NFR** - Compliance to TB 117-2013
 - FR** - Compliance to TB 133
- C** Select poly color. Refer to color addendum at ki.com or KI Fabrics & Finishes binder.
- D** Select frame finish. Refer to color addendum at ki.com or KI Fabrics & Finishes binder.
- E** Select bookrack color. Refer to color addendum at ki.com or KI Fabrics & Finishes binder.
- F** Select glide option.
 - GFT** - Felt glides
 - GPL** - Nylon plastic glides
 - GSL** - Steel glides

- G** Select upholstery grade/color. Refer to color addendum at ki.com or KI Fabrics & Finishes binder.



Ruckus™ Seating (Freight Excluded Pricing)

Stools

Approx. Packaged Weight	Freight Excluded Pricing Unupholstered	Freight Excluded Pricing Fabric Grade 1 & C.O.M.	Freight Excluded Pricing Fabric Grade 2	Freight Excluded Pricing Fabric Grade 3 & Group 2V Vinyl	Freight Excluded Pricing C.O.V.	Freight Excluded Pricing Pallas Fabric Group P0	Freight Excluded Pricing Pallas Fabric Group P1	Freight Excluded Pricing Pallas Fabric Group P2	Freight Excluded Pricing Pallas Fabric Group P3	Freight Excluded Pricing Pallas Fabric Group P4
45.0#	\$ 303									
46.0#	312									
47.5#	N/A	\$ 395	\$ 403	\$ 418	\$ 395	\$ 426	\$ 472	\$ 486	\$ 504	\$ 530
48.5#	N/A	404	412	427	404	435	481	495	513	539

UPHOLSTERY INFORMATION

C.O.M. Upholstery

C.O.M. requirement for 10 chairs or less with upholstered seat or upholstered seat and back is 3/4 yard per chair of 54" wide nondirectional fabric. For orders of 11 or more with upholstered seat and back and for complete information on ordering C.O.M. see "Ordering C.O.M., C.O.V. and C.O.L." section.

OPTIONS

California TB133 Fire Safety Code

The above seating products can be manufactured using the appropriate flame-retardant materials for compliance to California Technical Bulletin 133. Add "FR" to end of model number.
 Model=Polypropylene
 Added Lead Time=none
 Added List Price=\$19
 Model=Upholstered Seat Only
 Added Lead Time=none
 Added List Price=\$30

SPECIAL SERVICES

Special Carton Marking

With specially marked information N/C



Shipping

Shipped assembled f.o.b. Green Bay, Wisconsin 54302 factory. Freight class #125.

Specifications and prices are subject to change without prior notice.

Ruckus™ Seating (Freight Excluded Pricing)

Task Chair

	MODEL	Features	MODEL NUMBER						Approx. Packaged Weight	
			Basic Model	Fire Code	Poly Color	Frame Color	Caster Type	Upholstery Color		
 <p>RK51</p>	Task Chair • Ships KD, packaged 1 chair per carton • Utilizes 28" 5-blade base	Polypropylene	RK5100	<input type="checkbox"/> <input type="checkbox"/>	<input type="checkbox"/> <input type="checkbox"/>	<input type="checkbox"/>	<input type="checkbox"/> <input type="checkbox"/>		36.0#	
 <p>RK52</p>	Task Chair • Ships KD, packaged 1 chair per carton • Utilizes 28" 5-blade base	Upholstered Seat	RK5200	<input type="checkbox"/> <input type="checkbox"/>	<input type="checkbox"/> <input type="checkbox"/>	<input type="checkbox"/>	<input type="checkbox"/> <input type="checkbox"/>	<input type="checkbox"/> <input type="checkbox"/> <input type="checkbox"/> <input type="checkbox"/>	38.5#	

A **B** **C** **D** **E** **F**

HOW TO ORDER

Indicate the following information on order form:

- Quantity of each item.
- Model number, including options. See "How To Build a Model Number".
- Any special service required.

Note: • The indicates that a choice is required.

- The absence of the indicates that no choice is required.
- Alpha-numeric characters in place of indicate that no other alternatives are available.

HOW TO BUILD A MODEL NUMBER

- A** Select basic model.
- B** Select fire retardant.

NFR	- Compliance to TB 117-2013
FR	- Compliance to TB 133
- C** Select poly color.
Refer to color addendum at ki.com or KI Fabrics & Finishes binder.
- D** Select frame color.
Refer to color addendum at ki.com or KI Fabrics & Finishes binder.
- E** Select caster or glide type.

CHC	- Hard floor casters
CCC	- Carpet casters
GBG	- Bell glide
- F** Select upholstery grade/color.
Refer to color addendum at ki.com or KI Fabrics & Finishes binder.



Ruckus™ Seating (Freight Excluded Pricing)

Task Chair

Freight Excluded Pricing Unupholstered	Freight Excluded Pricing Fabric Grade 1 & C.O.M.	Freight Excluded Pricing Fabric Grade 2	Freight Excluded Pricing Fabric Grade 3 & Group 2V Vinyl	Freight Excluded Pricing C.O.V.	Freight Excluded Pricing Pallas Fabric Group P0	Freight Excluded Pricing Pallas Fabric Group P1	Freight Excluded Pricing Pallas Fabric Group P2	Freight Excluded Pricing Pallas Fabric Group P3	Freight Excluded Pricing Pallas Fabric Group P4
\$ 274									

N/A	\$ 366	\$ 374	\$ 389	\$ 366	\$ 397	\$ 443	\$ 457	\$ 475	\$ 501
-----	--------	--------	--------	--------	--------	--------	--------	--------	--------

UPHOLSTERY INFORMATION

C.O.M. Upholstery

C.O.M. requirement for 10 chairs or less with upholstered seat or upholstered seat and back is 3/4 yard per chair of 54" wide nondirectional fabric. For orders of 11 or more with upholstered seat and back and for complete information on ordering C.O.M. see "Ordering C.O.M., C.O.V. and C.O.L." section.

OPTIONS

California TB133 Fire Safety Code

The above seating products can be manufactured using the appropriate flame-retardant materials for compliance to California Technical Bulletin 133. Add "FR" to end of model number.
 Model=Polypropylene
 Added Lead Time=none
 Added List Price=\$19
 Model=Upholstered Seat Only
 Added Lead Time=none
 Added List Price=\$30

SPECIAL SERVICES

Special Carton Marking

With specially marked information N/C

Shipping

Shipped **k.d.f.o.b. Green Bay, Wisconsin 54302** factory. Freight class #125.

Specifications and prices are subject to change without prior notice.

Ruckus™ Desking (Freight Excluded Pricing)

Desk

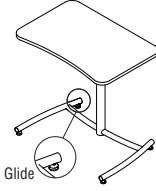
MODEL	Features	MODEL NUMBER						Approx. Packaged Weight	
		Basic Model	Storage Accessories	Base	Top Color	Edge Color	Base Color		
 <p>RU420</p>	Fixed Height - Glide Base • Laminate curved front only • 20" x 30" worksurface • Ships fully assembled, packaged 1 desk per carton	26" High	RU4207	<input type="checkbox"/> <input type="checkbox"/> <input type="checkbox"/> <input type="checkbox"/>	<input type="checkbox"/> <input type="checkbox"/>	<input type="checkbox"/> <input type="checkbox"/>	<input type="checkbox"/> <input type="checkbox"/>	<input type="checkbox"/> <input type="checkbox"/>	37.0#
	29" High	RU4201	<input type="checkbox"/> <input type="checkbox"/> <input type="checkbox"/> <input type="checkbox"/>	<input type="checkbox"/> <input type="checkbox"/>	<input type="checkbox"/> <input type="checkbox"/>	<input type="checkbox"/> <input type="checkbox"/>	<input type="checkbox"/> <input type="checkbox"/>	<input type="checkbox"/> <input type="checkbox"/>	39.0#

A **B** **C** **D** **E** **F**

HOW TO ORDER

Indicate the following information on order form:

- Quantity of each item.
- Model number, including options. See "How To Build a Model Number".
- Any special service required.

Note: • The indicates that a choice is required.

- The absence of the indicates that no choice is required.
- Alpha-numeric characters in place of indicate that no other alternatives are available.

HOW TO BUILD A MODEL NUMBER

- A** Select basic model.
- B** Select storage/accessories.

BH	- Book bag hook; add \$8
NB	- No book storage
- C** Select base option.

GFT	- Felt glides
GPL	- Nylon plastic glides
GSL	- Steel glides
- D** Select top laminate surface.
Refer to color addendum at ki.com or KI Fabrics & Finishes binder.
- E** Select edge color.
Refer to color addendum at ki.com or KI Fabrics & Finishes binder.
- F** Select base color.
Refer to color addendum at ki.com or KI Fabrics & Finishes binder.

FINISH INFORMATION

Additional Laminate Offering

Additional laminates beyond KI standard offering, are available with two weeks extended leadtime. To specify additional laminates, use these designators followed by the supplier's color/pattern code:

Formica - LF/supplier's color pattern code
 Nevamar - LN/supplier's color pattern code
 Wilsonart - LW/supplier's color pattern code

KI's standard finish is the supplier's recommended finish for that color/pattern. Note: Nonstandard laminates from these suppliers (example: textured laminates), require an upcharge and additional leadtime. Contact KI.



Ruckus™ Desking (Freight Excluded Pricing)

Desk

Freight
Excluded
Pricing

\$ 374

378

SPECIAL SERVICES

Special Carton Marking

With specially marked information N/C

Shipping

Shipped **assembled f.o.b. Green Bay, Wisconsin 54302** factory. Freight class #125.

Specifications and prices are subject to change without prior notice.

Ruckus™ Desking (Freight Excluded Pricing)

Desk

MODEL	Features	MODEL NUMBER						Approx. Packaged Weight
		Basic Model	Storage Accessories	Base	Top Color	Edge Color	Base Color	
 <p>Fixed Height - Rolling Base</p> <ul style="list-style-type: none"> Laminate curved front only 20" x 30" worksurface Ships fully assembled, packaged 1 desk per carton 	26" High	RU5207	<input type="checkbox"/> <input type="checkbox"/> <input type="checkbox"/> <input type="checkbox"/>	<input type="checkbox"/> <input type="checkbox"/>	<input type="checkbox"/> <input type="checkbox"/> <input type="checkbox"/>	<input type="checkbox"/> <input type="checkbox"/>	<input type="checkbox"/> <input type="checkbox"/>	37.0#
	29" High	RU5201	<input type="checkbox"/> <input type="checkbox"/> <input type="checkbox"/> <input type="checkbox"/>	<input type="checkbox"/> <input type="checkbox"/>	<input type="checkbox"/> <input type="checkbox"/> <input type="checkbox"/>	<input type="checkbox"/> <input type="checkbox"/>	<input type="checkbox"/> <input type="checkbox"/>	39.0#

RU520

A **B** **C** **D** **E** **F**

HOW TO ORDER

Indicate the following information on order form:

- Quantity of each item.
- Model number, including options. See "How To Build a Model Number".
- Any special service required.

Note:

- The indicates that a choice is required.
- The absence of the indicates that no choice is required.
- Alpha-numeric characters in place of indicate that no other alternatives are available.

HOW TO BUILD A MODEL NUMBER

Refer to color addendum at ki.com or KI Fabrics & Finishes binder.

- A** Select basic model.
- B** Select storage/accessories.
 - BH** - Book bag hook; add \$8
 - NB** - No book storage
- C** Select base option.
 - RSL** - Wheelbarrow (rolling front, steel glides back)
 - RPL** - Wheelbarrow (roller front, plastic glides back)
 - RFT** - Wheelbarrow (rolling front, felt solo glides back)
- D** Select top laminate surface. Refer to color addendum at ki.com or KI Fabrics & Finishes binder.
- E** Select edge color. Refer to color addendum at ki.com or KI Fabrics & Finishes binder.
- F** Select base color.

FINISH INFORMATION

Additional Laminate Offering

Additional laminates beyond KI standard offering, are available with two weeks extended leadtime. To specify additional laminates, use these designators followed by the supplier's color/pattern code:

Formica - LF/supplier's color pattern code
 Nevamar - LN/supplier's color pattern code
 Wilsonart - LW/supplier's color pattern code

KI's standard finish is the supplier's recommended finish for that color/pattern. Note: Nonstandard laminates from these suppliers (example: textured laminates), require an upcharge and additional leadtime. Contact KI.



Ruckus™ Desking (Freight Excluded Pricing)

Desk

Freight
Excluded
Pricing

\$ 404

408

SPECIAL SERVICES

Special Carton Marking

With specially marked information N/C



Shipping

Shipped **assembled f.o.b. Green Bay, Wisconsin 54302** factory. Freight class #125.

Specifications and prices are subject to change without prior notice.

Ruckus™ Storage (Freight Excluded Pricing)

Lockers

	MODEL	W x D x H	MODEL NUMBER					Approx. Packaged Weight
			Basic Model	Base	Top Color	Edge Color	Shell Color	
	Locker-Two Open Units	36x24x36	RKL362436OP	<input type="checkbox"/>	<input type="checkbox"/>	<input type="checkbox"/>	<input type="checkbox"/>	165.3#
	<ul style="list-style-type: none"> Laminate top (1-1/4" with 74P edge) Dual sided storage (4 compartments total) 2 hooks per opening Unit ships assembled; glides/casters are field installed 	36x24x42	RKL362442OP	<input type="checkbox"/>	<input type="checkbox"/>	<input type="checkbox"/>	<input type="checkbox"/>	178.5#
RCKL								
	Locker-Three Open Units	54x24x36	RKL542436OP	<input type="checkbox"/>	<input type="checkbox"/>	<input type="checkbox"/>	<input type="checkbox"/>	211.0#
	<ul style="list-style-type: none"> Laminate top (1-1/4" with 74P edge) Dual sided storage (6 compartments total) 2 hooks per opening Unit ships assembled; glides/casters are field installed 	54x24x42	RKL542442OP	<input type="checkbox"/>	<input type="checkbox"/>	<input type="checkbox"/>	<input type="checkbox"/>	229.0#
RCKL								
				A	B	C	D	E

HOW TO ORDER

Indicate the following information on order form:

- Quantity of each item.
- Model number, including options. See "How To Build a Model Number".
- Any special service required.

Note: • The indicates that a choice is required.

- The absence of the indicates that no choice is required.
- Alpha-numeric characters in place of indicate that no other alternatives are available.

HOW TO BUILD A MODEL NUMBER

- A** Select basic model.
- B** Select base option.
- | | |
|------------|-------------------|
| 4CW | - 4 black casters |
| 4GB | - 4 black glides |
- C** Select top laminate surface.
Refer to color addendum at ki.com or KI Fabrics & Finishes binder.
- D** Select edge color.
Refer to color addendum at ki.com or KI Fabrics & Finishes binder.
- E** Select shell color.
Refer to color addendum at ki.com or KI Fabrics & Finishes binder.

FINISH INFORMATION

Additional Laminate Offering

Additional laminates beyond KI standard offering, are available with two weeks extended leadtime. To specify additional laminates, use these designators followed by the supplier's color/pattern code:

Formica - LF/supplier's color pattern code
Nevamar - LN/supplier's color pattern code
Wilsonart - LW/supplier's color pattern code

KI's standard finish is the supplier's recommended finish for that color/pattern. Note: Nonstandard laminates from these suppliers (example: textured laminates), require an upcharge and additional leadtime. Contact KI.



Ruckus™ Storage (Freight Excluded Pricing)

Lockers

Freight
Excluded
Pricing

\$ 921

955

\$ 1192

1237

SPECIAL SERVICES

Special Carton Marking

With specially marked information N/C



Shipping

Shipped assembled f.o.b. Pembroke, Ontario K8A 0E1 factory. Freight class #100.

Specifications and prices are subject to change without prior notice.

Ruckus™ Storage (Freight Excluded Pricing)

Lockers

	W x D x H	MODEL NUMBER									Approx. Packaged Weight
		Basic Model	Door Lock Option	Pull Option	Base	Top Color	Edge Color	Shell Color	Door Color	Lock Option	
 <p>Hinged right shown</p> <p>RCKL Locker-Two Door Units</p> <ul style="list-style-type: none"> Laminate top (1-1/4" with 74P edge) Dual sided storage (4 compartments total) Secure locking doors 4 locking options offered Unit ships assembled; glides/casters are field installed 	36x24x36	RKL362436DR	<input type="checkbox"/> <input type="checkbox"/> <input type="checkbox"/> <input type="checkbox"/>	<input type="checkbox"/> <input type="checkbox"/>	<input type="checkbox"/> <input type="checkbox"/>	<input type="checkbox"/> <input type="checkbox"/>	<input type="checkbox"/> <input type="checkbox"/>	<input type="checkbox"/> <input type="checkbox"/>	<input type="checkbox"/> <input type="checkbox"/>	<input type="checkbox"/> <input type="checkbox"/>	192.1#
	36x24x42	RKL362442DR	<input type="checkbox"/> <input type="checkbox"/> <input type="checkbox"/> <input type="checkbox"/>	<input type="checkbox"/> <input type="checkbox"/>	<input type="checkbox"/> <input type="checkbox"/>	<input type="checkbox"/> <input type="checkbox"/>	<input type="checkbox"/> <input type="checkbox"/>	<input type="checkbox"/> <input type="checkbox"/>	<input type="checkbox"/> <input type="checkbox"/>	<input type="checkbox"/> <input type="checkbox"/>	<input type="checkbox"/> <input type="checkbox"/>
 <p>Hinged right shown</p> <p>RCKL Locker-Three Door Units</p> <ul style="list-style-type: none"> Laminate top (1-1/4" with 74P edge) Dual sided storage (6 compartments total) Secure locking doors 4 locking options offered Unit ships assembled; glides/casters are field installed 	54x24x36	RKL542436DR	<input type="checkbox"/> <input type="checkbox"/> <input type="checkbox"/> <input type="checkbox"/>	<input type="checkbox"/> <input type="checkbox"/>	<input type="checkbox"/> <input type="checkbox"/>	<input type="checkbox"/> <input type="checkbox"/>	<input type="checkbox"/> <input type="checkbox"/>	<input type="checkbox"/> <input type="checkbox"/>	<input type="checkbox"/> <input type="checkbox"/>	<input type="checkbox"/> <input type="checkbox"/>	251.2#
	54x24x42	RKL542442DR	<input type="checkbox"/> <input type="checkbox"/> <input type="checkbox"/> <input type="checkbox"/>	<input type="checkbox"/> <input type="checkbox"/>	<input type="checkbox"/> <input type="checkbox"/>	<input type="checkbox"/> <input type="checkbox"/>	<input type="checkbox"/> <input type="checkbox"/>	<input type="checkbox"/> <input type="checkbox"/>	<input type="checkbox"/> <input type="checkbox"/>	<input type="checkbox"/> <input type="checkbox"/>	<input type="checkbox"/> <input type="checkbox"/>

A B C D E F G H I

HOW TO ORDER

Indicate the following information on order form:

- Quantity of each item.
- Model number, including options. See "How To Build a Model Number".
- Any special service required.

Note:

- The indicates that a choice is required.
- The absence of the indicates that no choice is required.
- Alpha-numeric characters in place of indicate that no other alternatives are available.

HOW TO BUILD A MODEL NUMBER

- A** Select basic model.
- B** Select door lock option.
 - SLCKL** - Standard lock hinged left
 - SLCKR** - Standard lock hinged right
 - PLCKL** - Padlock hinged left
 - PLCKR** - Padlock hinged right
 - CLCKL** - Combination lock hinged left
 - CLCKR** - Combination lock hinged right
 - DLCKL** - Digital lock hinged left
 - DLCKR** - Digital lock hinged right
- C** Select pull option.
 - S6** - Beveled pull Black
 - S5** - Beveled pull Satin Chrome
 Pull selection only when SLCKR or SLCKL key lock is selected.
- D** Select base option.
 - 4CW** - 4 black casters
 - 4GB** - 4 black glides

- E** Select top laminate surface. Refer to color addendum at ki.com or KI Fabrics & Finishes binder.
- F** Select edge color. Refer to color addendum at ki.com or KI Fabrics & Finishes binder.
- G** Select shell color. Refer to color addendum at ki.com or KI Fabrics & Finishes binder.
- H** Select front door color. Refer to color addendum at ki.com or KI Fabrics & Finishes binder.
- I** Select lock option
 - KA** - Key alike
 - KS** - Key standard
 - NLC** - No lock core
 Available ONLY when the standard lock is selected.

FINISH INFORMATION

Additional Laminate Offering

Additional laminates beyond KI standard offering, are available with two weeks extended leadtime. To specify additional laminates, use these designators followed by the supplier's color/pattern code:

Formica - LF/supplier's color pattern code
 Nevamar - LN/supplier's color pattern code
 Wilsonart - LW/supplier's color pattern code

KI's standard finish is the supplier's recommended finish for that color/pattern. Note: Nonstandard laminates from these suppliers (example: textured laminates), require an upcharge and additional leadtime. Contact KI.

Ruckus™ Storage (Freight Excluded Pricing)

Bookcase

MODEL	W x D x H	MODEL NUMBER					Approx. Packaged Weight
		Basic Model	Base	Top Color	Edge Color	Shell Color	
 <p>Bookcase Unit with Shelves</p> <ul style="list-style-type: none"> Laminate top (1-1/4" with 74P edge) Dual sided storage 3 compartments per side (6 total) Unit ships assembled; glides/casters are field installed 	36x24x36	RKB362436	<input type="checkbox"/> <input type="checkbox"/>	<input type="checkbox"/> <input type="checkbox"/>	<input type="checkbox"/> <input type="checkbox"/>	<input type="checkbox"/> <input type="checkbox"/>	161.0#
	36x24x42	RKB362442	<input type="checkbox"/> <input type="checkbox"/>	<input type="checkbox"/> <input type="checkbox"/>	<input type="checkbox"/> <input type="checkbox"/>	<input type="checkbox"/> <input type="checkbox"/>	170.6#

RCKB

A **B** **C** **D** **E**

HOW TO ORDER

Indicate the following information on order form:

- Quantity of each item.
- Model number, including options. See "How To Build a Model Number".
- Any special service required.

Note: • The indicates that a choice is required.

- The absence of the indicates that no choice is required.
- Alpha-numeric characters in place of indicate that no other alternatives are available.

HOW TO BUILD A MODEL NUMBER

- A** Select basic model.
- B** Select base option.

4CW	- 4 black casters
4GB	- 4 black glides
- C** Select top laminate surface. Refer to color addendum at ki.com or KI Fabrics & Finishes binder.
- D** Select edge color. Refer to color addendum at ki.com or KI Fabrics & Finishes binder.
- E** Select shell color. Refer to color addendum at ki.com or KI Fabrics & Finishes binder.

FINISH INFORMATION

Additional Laminate Offering

Additional laminates beyond KI standard offering, are available with two weeks extended leadtime. To specify additional laminates, use these designators followed by the supplier's color/pattern code:

Formica - LF/supplier's color pattern code
 Nevamar - LN/supplier's color pattern code
 Wilsonart - LW/supplier's color pattern code

KI's standard finish is the supplier's recommended finish for that color/pattern. Note: Nonstandard laminates from these suppliers (example: textured laminates), require an upcharge and additional leadtime. Contact KI.



Ruckus™ Storage (Freight Excluded Pricing)

Bookcase

Freight
Excluded
Pricing

\$ 907

953

SPECIAL SERVICES

Special Carton Marking

With specially marked information N/C



Shipping

Shipped **assembled f.o.b. Pembroke, Ontario K8A 0E1** factory. Freight class #100.

Specifications and prices are subject to change without prior notice.

Ruckus™ Storage (Freight Excluded Pricing)

Cubbies

	MODEL	W x D x H	MODEL NUMBER					Approx. Packaged Weight
			Basic Model	Base	Top Color	Edge Color	Shell Color	
	Cubbies 2x3-Open Units • Laminate top (1-1/4" with 74P edge) • Dual sided storage (12 total compartments) • Unit ships assembled; glides/casters are field installed	36x24x36	RKC362436OP	<input type="checkbox"/>	<input type="checkbox"/>	<input type="checkbox"/>	<input type="checkbox"/>	181.4#
		36x24x42	RKC362442OP	<input type="checkbox"/>	<input type="checkbox"/>	<input type="checkbox"/>	<input type="checkbox"/>	194.6#
RCKC								
	Cubbies 3x3-Open Units • Laminate top (1-1/4" with 74P edge) • Dual sided storage (18 total compartments) • Unit ships assembled; glides/casters are field installed	54x24x36	RKC542436OP	<input type="checkbox"/>	<input type="checkbox"/>	<input type="checkbox"/>	<input type="checkbox"/>	235.2#
		54x24x42	RKC542442OP	<input type="checkbox"/>	<input type="checkbox"/>	<input type="checkbox"/>	<input type="checkbox"/>	253.1#
RCKC								
				A	B	C	D	E

HOW TO ORDER

Indicate the following information on order form:

- Quantity of each item.
- Model number, including options. See "How To Build a Model Number".
- Any special service required.

Note: • The indicates that a choice is required.

- The absence of the indicates that no choice is required.
- Alpha-numeric characters in place of indicate that no other alternatives are available.

HOW TO BUILD A MODEL NUMBER

- A** Select basic model.
- B** Select base option.
4CW - 4 black casters
4GB - 4 black glides
- C** Select top laminate surface.
 Refer to color addendum at ki.com or KI Fabrics & Finishes binder.
- D** Select edge color.
 Refer to color addendum at ki.com or KI Fabrics & Finishes binder.
- E** Select shell color.
 Refer to color addendum at ki.com or KI Fabrics & Finishes binder.

FINISH INFORMATION

Additional Laminate Offering

Additional laminates beyond KI standard offering, are available with two weeks extended leadtime. To specify additional laminates, use these designators followed by the supplier's color/pattern code:

Formica - LF/supplier's color pattern code
 Nevamar - LN/supplier's color pattern code
 Wilsonart - LW/supplier's color pattern code

KI's standard finish is the supplier's recommended finish for that color/pattern. Note: Nonstandard laminates from these suppliers (example: textured laminates), require an upcharge and additional leadtime. Contact KI.



Ruckus™ Storage (Freight Excluded Pricing)

Cubbies

Freight
Excluded
Pricing

\$ 963

997

\$ 1254

1299

SPECIAL SERVICES

Special Carton Marking

With specially marked information N/C

Shipping

Shipped **assembled f.o.b. Pembroke, Ontario K8A 0E1** factory. Freight class #100.

Specifications and prices are subject to change without prior notice.

Ruckus™ Storage (Freight Excluded Pricing)

Cubbies

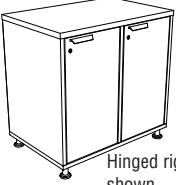
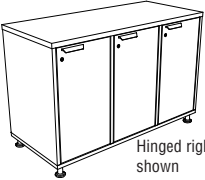
	W x D x H	MODEL NUMBER									Approx. Packaged Weight
		Basic Model	Door Lock Option	Pull Option	Base	Top Color	Edge Color	Shell Color	Door Color	Lock Option	
 <p>Hinged right shown</p> <p>RCKC Cubbies 2x3-With Doors</p> <ul style="list-style-type: none"> Laminate top (1-1/4" with 74P edge) Dual sided storage (12 total compartments) Secure locking doors 4 Locking options offered Unit ships assembled; glides/casters are field installed 	36x24x36	RKC362436DR	<input type="checkbox"/> <input type="checkbox"/> <input type="checkbox"/> <input type="checkbox"/>	<input type="checkbox"/> <input type="checkbox"/>	<input type="checkbox"/> <input type="checkbox"/>	<input type="checkbox"/> <input type="checkbox"/>	<input type="checkbox"/> <input type="checkbox"/>	<input type="checkbox"/> <input type="checkbox"/>	<input type="checkbox"/> <input type="checkbox"/>	<input type="checkbox"/> <input type="checkbox"/>	208.2#
	36x24x42	RKC362442DR	<input type="checkbox"/> <input type="checkbox"/> <input type="checkbox"/> <input type="checkbox"/>	<input type="checkbox"/> <input type="checkbox"/>	<input type="checkbox"/> <input type="checkbox"/>	<input type="checkbox"/> <input type="checkbox"/>	<input type="checkbox"/> <input type="checkbox"/>	<input type="checkbox"/> <input type="checkbox"/>	<input type="checkbox"/> <input type="checkbox"/>	<input type="checkbox"/> <input type="checkbox"/>	<input type="checkbox"/> <input type="checkbox"/>
 <p>Hinged right shown</p> <p>RCKC Cubbies 3x3-With Doors</p> <ul style="list-style-type: none"> Laminate top (1-1/4" with 74P edge) Dual sided storage (18 total compartments) Secure locking doors 4 Locking options offered Unit ships assembled; glides/casters are field installed 	54x24x36	RKC542436DR	<input type="checkbox"/> <input type="checkbox"/> <input type="checkbox"/> <input type="checkbox"/>	<input type="checkbox"/> <input type="checkbox"/>	<input type="checkbox"/> <input type="checkbox"/>	<input type="checkbox"/> <input type="checkbox"/>	<input type="checkbox"/> <input type="checkbox"/>	<input type="checkbox"/> <input type="checkbox"/>	<input type="checkbox"/> <input type="checkbox"/>	<input type="checkbox"/> <input type="checkbox"/>	275.4#
	54x24x42	RKC542442DR	<input type="checkbox"/> <input type="checkbox"/> <input type="checkbox"/> <input type="checkbox"/>	<input type="checkbox"/> <input type="checkbox"/>	<input type="checkbox"/> <input type="checkbox"/>	<input type="checkbox"/> <input type="checkbox"/>	<input type="checkbox"/> <input type="checkbox"/>	<input type="checkbox"/> <input type="checkbox"/>	<input type="checkbox"/> <input type="checkbox"/>	<input type="checkbox"/> <input type="checkbox"/>	<input type="checkbox"/> <input type="checkbox"/>
			A	B	C	D	E	F	G	H	I

HOW TO ORDER

Indicate the following information on order form:

- Quantity of each item.
- Model number, including options. See "How To Build a Model Number".
- Any special service required.

Note: • The indicates that a choice is required.

- The absence of the indicates that no choice is required.
- Alpha-numeric characters in place of indicate that no other alternatives are available.

HOW TO BUILD A MODEL NUMBER

- A** Select basic model.
- B** Select door lock option.
 - SLCKL** - Standard lock hinged left
 - SLCKR** - Standard lock hinged right
 - PLCKL** - Padlock hinged left
 - PLCKR** - Padlock hinged right
 - CLCKL** - Combination lock hinged left
 - CLCKR** - Combination lock hinged right
 - DLCKL** - Digital lock hinged left
 - DLCKR** - Digital lock hinged right
- C** Select pull option.
 - S6** - Beveled pull Black
 - S5** - Beveled pull Satin Chrome
 Pull selection only when SLCKR or SLCKL key lock is selected.
- D** Select base option.
 - 4CW** - 4 black casters
 - 4GB** - 4 black glides

- E** Select top laminate surface. Refer to color addendum at ki.com or KI Fabrics & Finishes binder.
- F** Select edge color. Refer to color addendum at ki.com or KI Fabrics & Finishes binder.
- G** Select shell color. Refer to color addendum at ki.com or KI Fabrics & Finishes binder.
- H** Select front door color. Refer to color addendum at ki.com or KI Fabrics & Finishes binder.
- I** Select lock option
 - KA** - Key alike
 - KS** - Key standard
 - NLC** - No lock core
 Available ONLY when the standard lock is selected.

FINISH INFORMATION

Additional Laminate Offering

Additional laminates beyond KI standard offering, are available with two weeks extended leadtime. To specify additional laminates, use these designators followed by the supplier's color/pattern code:

Formica - LF/supplier's color pattern code
 Nevamar - LN/supplier's color pattern code
 Wilsonart - LW/supplier's color pattern code

KI's standard finish is the supplier's recommended finish for that color/pattern. Note: Nonstandard laminates from these suppliers (example: textured laminates), require an upcharge and additional leadtime. Contact KI.



Ruckus™ Storage (Freight Excluded Pricing)

Cubbies

Freight Excluded Pricing Standard Lock	Freight Excluded Pricing Padlock	Freight Excluded Pricing Combination Lock	Freight Excluded Pricing Digital Lock
\$ 1257	\$ 1292	\$ 1545	\$ 2043
1299	1333	1587	2084

\$ 1673	\$ 1724	\$ 2104	\$ 2851
1729	1781	2161	2907

SPECIAL SERVICES

Special Carton Marking

With specially marked information N/C

Shipping

Shipped assembled f.o.b. **Pembroke, Ontario K8A 0E1** factory. Freight class #100.

Specifications and prices are subject to change without prior notice.

Ruckus™ Storage (Freight Excluded Pricing)

Storage Accessories

	MODEL	Features	MODEL NUMBER	
			Basic Model	Approx. Packaged Weight
HRDPT	Double Bit Keys	Master Key	2.KP20550	0.2#
		Extractor Key	2.KP20551	0.2#
		Key Blank	2.KP20552	0.2#
		Cut Key	2.KP20557	0.2#
HRDPT	Locker Master Key for CLCK Lock	<ul style="list-style-type: none"> Master key for CLCK combination locks used on Ruckus storage lockers and cubbies ONLY Not for use with any other locks except Ruckus combination locks 	2.KP61614	0.2#
HRDPT	Locker Master Key for DLCK Lock	<ul style="list-style-type: none"> Master key for DLCK digital locks used on Ruckus storage lockers and cubbies ONLY Not for use with any other locks except Ruckus digital locks 	2.KP61616	0.2#

A

HOW TO ORDER

Indicate the following information on order form:

- Quantity of each item.
- Model number, including options. See "How To Build a Model Number".
- Any special service required.

Note: • The indicates that a choice is required.

- The absence of the indicates that no choice is required.
- Alpha-numeric characters in place of indicate that no other alternatives are available.

HOW TO BUILD A MODEL NUMBER

A Select basic model.



Ruckus™ Storage (Freight Excluded Pricing)

Storage Accessories

Freight
Excluded
Pricing

\$ 9
9
3
4
\$ 21

\$ 7

SPECIAL SERVICES

Special Carton Marking

With specially marked information N/C



Shipping

Shipped **assembled freight prepaid f.o.b. Pembroke, Ontario K8A 0E1** factory.
Freight class #70.

Specifications and prices are subject to change without prior notice.

Ruckus™ Seating (Delivered Pricing)

Four-Leg Chair

	MODEL	Features	H	MODEL NUMBER					
				Basic Model	Fire Code	Poly Color	Frame Color	Glide Option	Upholstery Color
	Four-Leg Chair with Glides • Model does not stack • Ships fully assembled, packaged 1 chair per carton	Polypropylene	15"	RK1100H15NB	<input type="checkbox"/> <input type="checkbox"/> <input type="checkbox"/>	<input type="checkbox"/> <input type="checkbox"/> <input type="checkbox"/>	<input type="checkbox"/> <input type="checkbox"/>	<input type="checkbox"/> <input type="checkbox"/> <input type="checkbox"/>	
		Polypropylene	18"	RK1100H18NB	<input type="checkbox"/> <input type="checkbox"/> <input type="checkbox"/>	<input type="checkbox"/> <input type="checkbox"/> <input type="checkbox"/>	<input type="checkbox"/> <input type="checkbox"/>	<input type="checkbox"/> <input type="checkbox"/> <input type="checkbox"/>	
RK11									
	Four-Leg Chair with Glides • Model does not stack • Ships fully assembled, packaged 1 chair per carton	Upholstered Seat	15"	RK1200H15NB	<input type="checkbox"/> <input type="checkbox"/> <input type="checkbox"/>	<input type="checkbox"/> <input type="checkbox"/> <input type="checkbox"/>	<input type="checkbox"/> <input type="checkbox"/>	<input type="checkbox"/> <input type="checkbox"/> <input type="checkbox"/> <input type="checkbox"/>	
		Upholstered Seat	18"	RK1200H18NB	<input type="checkbox"/> <input type="checkbox"/> <input type="checkbox"/>	<input type="checkbox"/> <input type="checkbox"/> <input type="checkbox"/>	<input type="checkbox"/> <input type="checkbox"/>	<input type="checkbox"/> <input type="checkbox"/> <input type="checkbox"/> <input type="checkbox"/>	
RK12									

A **B** **C** **D** **E** **F**

HOW TO ORDER

Indicate the following information on order form:

- Quantity of each item.
- Model number, including options. See "How To Build a Model Number".
- Any special service required.

Note: • The indicates that a choice is required.

- The absence of the indicates that no choice is required.
- Alpha-numeric characters in place of indicate that no other alternatives are available.

HOW TO BUILD A MODEL NUMBER

- A** Select basic model.
- B** Select fire retardant.

NFR	- Compliance to TB 117-2013
FR	- Compliance to TB 133
- C** Select poly color.
Refer to color addendum at ki.com or KI Fabrics & Finishes binder.
- D** Select frame finish.
Refer to color addendum at ki.com or KI Fabrics & Finishes binder.
- E** Select glide option.

GFT	- Felt glides
GPL	- Nylon plastic glides
GSL	- Steel glides
- F** Select upholstery grade/color.
Refer to color addendum at ki.com or KI Fabrics & Finishes binder.



Ruckus™ Seating (Delivered Pricing)

Four-Leg Chair

Approx. Packaged Weight	Delivered Pricing Unupholstered	Delivered Pricing Fabric Grade 1 & C.O.M.	Delivered Pricing Fabric Grade 2	Delivered Pricing Fabric Grade 3 & Group 2V Vinyl	Delivered Pricing C.O.V.	Delivered Pricing Pallas Fabric Group P0	Delivered Pricing Pallas Fabric Group P1	Delivered Pricing Pallas Fabric Group P2	Delivered Pricing Pallas Fabric Group P3	Delivered Pricing Pallas Fabric Group P4
29.0#	\$ 175									
30.0#	177									
31.5#	N/A	\$ 276	\$ 284	\$ 299	\$ 276	\$ 307	\$ 353	\$ 367	\$ 385	\$ 411
32.5#	N/A	279	287	302	279	310	356	370	388	414

UPHOLSTERY INFORMATION

C.O.M. Upholstery

C.O.M. requirement for 10 chairs or less with upholstered seat or upholstered seat and back is 3/4 yard per chair of 54" wide nondirectional fabric. For orders of 11 or more with upholstered seat and back and for complete information on ordering C.O.M. see "Ordering C.O.M., C.O.V. and C.O.L." section.

OPTIONS

California TB133 Fire Safety Code

The above seating products can be manufactured using the appropriate flame-retardant materials for compliance to California Technical Bulletin 133. Add "FR" to end of model number.
 Model=Polypropylene
 Added Lead Time=none
 Added List Price=\$19
 Model=Upholstered Seat Only
 Added Lead Time=none
 Added List Price=\$30

SPECIAL SERVICES

Special Carton Marking

With specially marked information N/C



Shipping

Shipped **assembled freight prepaid f.o.b. Green Bay, Wisconsin 54302** factory. Freight class #125.

Specifications and prices are subject to change without prior notice.

Ruckus™ Seating (Delivered Pricing)

Four-Leg Chair

	MODEL	Features	H	MODEL NUMBER					
				Basic Model	Fire Code	Poly Color	Frame Color	Caster Type	Upholstery Color
 <p>RK21</p>	Four-Leg Chair with Casters • Model does not stack • Ships fully assembled, packaged 1 chair per carton	Polypropylene	15"	RK2100H15NB	<input type="checkbox"/> <input type="checkbox"/> <input type="checkbox"/>	<input type="checkbox"/> <input type="checkbox"/> <input type="checkbox"/>	<input type="checkbox"/> <input type="checkbox"/>	<input type="checkbox"/> <input type="checkbox"/> <input type="checkbox"/>	
		Polypropylene	18"	RK2100H18NB	<input type="checkbox"/> <input type="checkbox"/> <input type="checkbox"/>	<input type="checkbox"/> <input type="checkbox"/> <input type="checkbox"/>	<input type="checkbox"/> <input type="checkbox"/>	<input type="checkbox"/> <input type="checkbox"/> <input type="checkbox"/>	
 <p>RK22</p>	Four-Leg Chair with Casters • Model does not stack • Ships fully assembled, packaged 1 chair per carton	Upholstered Seat	15"	RK2200H15NB	<input type="checkbox"/> <input type="checkbox"/> <input type="checkbox"/>	<input type="checkbox"/> <input type="checkbox"/> <input type="checkbox"/>	<input type="checkbox"/> <input type="checkbox"/>	<input type="checkbox"/> <input type="checkbox"/> <input type="checkbox"/> <input type="checkbox"/> <input type="checkbox"/> <input type="checkbox"/>	
		Upholstered Seat	18"	RK2200H18NB	<input type="checkbox"/> <input type="checkbox"/> <input type="checkbox"/>	<input type="checkbox"/> <input type="checkbox"/> <input type="checkbox"/>	<input type="checkbox"/> <input type="checkbox"/>	<input type="checkbox"/> <input type="checkbox"/> <input type="checkbox"/> <input type="checkbox"/> <input type="checkbox"/> <input type="checkbox"/>	

A **B** **C** **D** **E** **F**

HOW TO ORDER

Indicate the following information on order form:

1. Quantity of each item.
2. Model number, including options. See "How To Build a Model Number".
3. Any special service required.

Note:

- The indicates that a choice is required.
- The absence of the indicates that no choice is required.
- Alpha-numeric characters in place of indicate that no other alternatives are available.

HOW TO BUILD A MODEL NUMBER

- A** Select basic model.
- B** Select fire retardant.

NFR	- Compliance to TB 117-2013
FR	- Compliance to TB 133
- C** Select poly color.
Refer to color addendum at ki.com or KI Fabrics & Finishes binder.
- D** Select frame finish.
Refer to color addendum at ki.com or KI Fabrics & Finishes binder.
- E** Select caster type.

CCC	- Carpet casters
CHC	- Hard floor casters
- F** Select upholstery grade/color.
Refer to color addendum at ki.com or KI Fabrics & Finishes binder.



Ruckus™ Seating (Delivered Pricing)

Four-Leg Chair

Approx. Packaged Weight	Delivered Pricing Unupholstered	Delivered Pricing Fabric Grade 1 & C.O.M.	Delivered Pricing Fabric Grade 2	Delivered Pricing Fabric Grade 3 & Group 2V Vinyl	Delivered Pricing C.O.V.	Delivered Pricing Pallas Fabric Group P0	Delivered Pricing Pallas Fabric Group P1	Delivered Pricing Pallas Fabric Group P2	Delivered Pricing Pallas Fabric Group P3	Delivered Pricing Pallas Fabric Group P4
29.5#	\$ 187									
30.5#	190									
32.0#	N/A	\$ 288	\$ 296	\$ 311	\$ 288	\$ 319	\$ 365	\$ 379	\$ 397	\$ 423
33.0#	N/A	291	299	314	291	322	368	382	400	426

UPHOLSTERY INFORMATION

C.O.M. Upholstery

C.O.M. requirement for 10 chairs or less with upholstered seat or upholstered seat and back is 3/4 yard per chair of 54" wide nondirectional fabric. For orders of 11 or more with upholstered seat and back and for complete information on ordering C.O.M. see "Ordering C.O.M., C.O.V. and C.O.L." section.

OPTIONS

California TB133 Fire Safety Code

The above seating products can be manufactured using the appropriate flame-retardant materials for compliance to California Technical Bulletin 133. Add "FR" to end of model number.
 Model=Polypropylene
 Added Lead Time=none
 Added List Price=\$19
 Model=Upholstered Seat Only
 Added Lead Time=none
 Added List Price=\$30

SPECIAL SERVICES

Special Carton Marking

With specially marked information N/C



Shipping

Shipped **assembled freight prepaid f.o.b. Green Bay, Wisconsin 54302** factory. Freight class #125.

Specifications and prices are subject to change without prior notice.

Ruckus™ Seating (Delivered Pricing)

Stack Chair with Glides

	MODEL	Features	H	MODEL NUMBER					
				Basic Model	Fire Code	Poly Color	Frame Color	Glide Option	Upholstery Color
 RKU1	Stack Chair with Glides • Ships fully assembled, packaged 2 chairs per carton • 15" chair stacks 3 high • 18" chair stacks 4 high	Polypropylene	15"	RKU100H15NB	<input type="checkbox"/> <input type="checkbox"/> <input type="checkbox"/>	<input type="checkbox"/> <input type="checkbox"/> <input type="checkbox"/>	<input type="checkbox"/> <input type="checkbox"/>	<input type="checkbox"/> <input type="checkbox"/> <input type="checkbox"/>	
		Polypropylene	18"	RKU100H18NB	<input type="checkbox"/> <input type="checkbox"/> <input type="checkbox"/>	<input type="checkbox"/> <input type="checkbox"/> <input type="checkbox"/>	<input type="checkbox"/> <input type="checkbox"/>	<input type="checkbox"/> <input type="checkbox"/> <input type="checkbox"/>	
 RKU2	Stack Chair with Glides • Ships fully assembled, packaged 1 chair per carton • 15" chair stacks 2 high • 18" chair stacks 3 high	Upholstered Seat	15"	RKU200H15NB	<input type="checkbox"/> <input type="checkbox"/> <input type="checkbox"/>	<input type="checkbox"/> <input type="checkbox"/> <input type="checkbox"/>	<input type="checkbox"/> <input type="checkbox"/>	<input type="checkbox"/> <input type="checkbox"/> <input type="checkbox"/>	<input type="checkbox"/> <input type="checkbox"/> <input type="checkbox"/> <input type="checkbox"/>
		Upholstered Seat	18"	RKU200H18NB	<input type="checkbox"/> <input type="checkbox"/> <input type="checkbox"/>	<input type="checkbox"/> <input type="checkbox"/> <input type="checkbox"/>	<input type="checkbox"/> <input type="checkbox"/>	<input type="checkbox"/> <input type="checkbox"/> <input type="checkbox"/>	<input type="checkbox"/> <input type="checkbox"/> <input type="checkbox"/> <input type="checkbox"/>
				A	B	C	D	E	F

HOW TO ORDER

Indicate the following information on order form:

- Quantity of each item.
- Model number, including options. See "How To Build a Model Number".
- Any special service required.

Note: • The indicates that a choice is required.

- The absence of the indicates that no choice is required.
- Alpha-numeric characters in place of indicate that no other alternatives are available.

HOW TO BUILD A MODEL NUMBER

- A** Select basic model.
- B** Select fire retardant.
- | | |
|------------|-----------------------------|
| NFR | - Compliance to TB 117-2013 |
| FR | - Compliance to TB 133 |
- C** Select poly color.
Refer to color addendum at ki.com or KI Fabrics & Finishes binder.
- D** Select frame finish.
Refer to color addendum at ki.com or KI Fabrics & Finishes binder.
- E** Select glide option.
- | | |
|------------|------------------------|
| GFT | - Felt glides |
| GPL | - Nylon plastic glides |
| GSL | - Steel glides |
- F** Select upholstery grade/color.
Refer to color addendum at ki.com or KI Fabrics & Finishes binder.



Ruckus™ Seating (Delivered Pricing)

Stack Chair with Glides

Approx. Packaged Weight	Delivered Pricing Unupholstered	Delivered Pricing Fabric Grade 1 & C.O.M.	Delivered Pricing Fabric Grade 2	Delivered Pricing Fabric Grade 3 & Group 2V Vinyl	Delivered Pricing C.O.V.	Delivered Pricing Pallas Fabric Group P0	Delivered Pricing Pallas Fabric Group P1	Delivered Pricing Pallas Fabric Group P2	Delivered Pricing Pallas Fabric Group P3	Delivered Pricing Pallas Fabric Group P4
34.0#	\$ 237									
35.0#	240									
36.5#	N/A	\$ 338	\$ 346	\$ 361	\$ 338	\$ 369	\$ 415	\$ 429	\$ 447	\$ 473
37.5#	N/A	341	349	364	341	372	418	432	450	476

UPHOLSTERY INFORMATION

C.O.M. Upholstery

C.O.M. requirement for 10 chairs or less with upholstered seat or upholstered seat and back is 3/4 yard per chair of 54" wide nondirectional fabric. For orders of 11 or more with upholstered seat and back and for complete information on ordering C.O.M. see "Ordering C.O.M., C.O.V. and C.O.L." section.

OPTIONS

California TB133 Fire Safety Code

The above seating products can be manufactured using the appropriate flame-retardant materials for compliance to California Technical Bulletin 133. Add "FR" to end of model number.
 Model=Polypropylene
 Added Lead Time=none
 Added List Price=\$19
 Model=Upholstered Seat Only
 Added Lead Time=none
 Added List Price=\$30

SPECIAL SERVICES

Special Carton Marking

With specially marked information N/C



Shipping

Shipped **assembled freight prepaid f.o.b. Green Bay, Wisconsin 54302** factory. Freight class #125.

Specifications and prices are subject to change without prior notice.

Ruckus™ Seating (Delivered Pricing)

Stack Chair with Glides

	MODEL	Features	H	MODEL NUMBER							
				Basic Model	Fire Code	Poly Color	Frame Color	Bookrack Color	Glide Option	Upholstery Color	
 <p>RKU1</p>	Stack Chair with Glides and Bookrack	Polypropylene	15"	RKU100H15BR	<input type="checkbox"/> <input type="checkbox"/> <input type="checkbox"/>	<input type="checkbox"/> <input type="checkbox"/> <input type="checkbox"/>	<input type="checkbox"/>	<input type="checkbox"/> <input type="checkbox"/> <input type="checkbox"/> <input type="checkbox"/>	<input type="checkbox"/> <input type="checkbox"/> <input type="checkbox"/>		
		• Ships fully assembled, packaged 2 chairs per carton	Polypropylene	18"	RKU100H18BR	<input type="checkbox"/> <input type="checkbox"/> <input type="checkbox"/>	<input type="checkbox"/> <input type="checkbox"/> <input type="checkbox"/>	<input type="checkbox"/>	<input type="checkbox"/> <input type="checkbox"/> <input type="checkbox"/> <input type="checkbox"/>	<input type="checkbox"/> <input type="checkbox"/> <input type="checkbox"/>	
		• 15" chair stacks 3 high									
		• 18" chair stacks 4 high									
 <p>RKU2</p>	Stack Chair with Glides and Bookrack	Upholstered Seat	15"	RKU200H15BR	<input type="checkbox"/> <input type="checkbox"/> <input type="checkbox"/>	<input type="checkbox"/> <input type="checkbox"/> <input type="checkbox"/>	<input type="checkbox"/>	<input type="checkbox"/> <input type="checkbox"/> <input type="checkbox"/> <input type="checkbox"/>	<input type="checkbox"/> <input type="checkbox"/> <input type="checkbox"/>	<input type="checkbox"/> <input type="checkbox"/> <input type="checkbox"/> <input type="checkbox"/>	
		• Ships fully assembled, packaged 1 chair per carton	Upholstered Seat	18"	RKU200H18BR	<input type="checkbox"/> <input type="checkbox"/> <input type="checkbox"/>	<input type="checkbox"/> <input type="checkbox"/> <input type="checkbox"/>	<input type="checkbox"/>	<input type="checkbox"/> <input type="checkbox"/> <input type="checkbox"/> <input type="checkbox"/>	<input type="checkbox"/> <input type="checkbox"/> <input type="checkbox"/>	<input type="checkbox"/> <input type="checkbox"/> <input type="checkbox"/> <input type="checkbox"/>
		• 15" chair stacks 2 high									
		• 18" chair stacks 3 high									

A **B** **C** **D** **E** **F** **G**

HOW TO ORDER

Indicate the following information on order form:

- Quantity of each item.
- Model number, including options. See "How To Build a Model Number".
- Any special service required.

Note: • The indicates that a choice is required.

- The absence of the indicates that no choice is required.
- Alpha-numeric characters in place of indicate that no other alternatives are available.

HOW TO BUILD A MODEL NUMBER

- A** Select basic model.

NFR	- Compliance to TB 117-2013
FR	- Compliance to TB 133
- B** Select fire retardant.
- C** Select poly color.
Refer to color addendum at ki.com or KI Fabrics & Finishes binder.
- D** Select frame finish.
Refer to color addendum at ki.com or KI Fabrics & Finishes binder.
- E** Select bookrack color.
Refer to color addendum at ki.com or KI Fabrics & Finishes binder.
- F** Select glide option.

GFT	- Felt glides
GPL	- Nylon plastic glides
GSL	- Steel glides

- G** Select upholstery grade/color.
Refer to color addendum at ki.com or KI Fabrics & Finishes binder.



Ruckus™ Seating (Delivered Pricing)

Stack Chair with Glides

Approx. Packaged Weight	Delivered Pricing Unupholstered	Delivered Pricing Fabric Grade 1 & C.O.M.	Delivered Pricing Fabric Grade 2	Delivered Pricing Fabric Grade 3 & Group 2V Vinyl	Delivered Pricing C.O.V.	Delivered Pricing Pallas Fabric Group P0	Delivered Pricing Pallas Fabric Group P1	Delivered Pricing Pallas Fabric Group P2	Delivered Pricing Pallas Fabric Group P3	Delivered Pricing Pallas Fabric Group P4
37.0#	\$ 288									
38.0#	292									
39.5#	N/A	\$ 390	\$ 398	\$ 413	\$ 390	\$ 421	\$ 467	\$ 481	\$ 499	\$ 525
40.5#	N/A	405	413	428	405	436	482	496	514	540

UPHOLSTERY INFORMATION

C.O.M. Upholstery

C.O.M. requirement for 10 chairs or less with upholstered seat or upholstered seat and back is 3/4 yard per chair of 54" wide nondirectional fabric. For orders of 11 or more with upholstered seat and back and for complete information on ordering C.O.M. see "Ordering C.O.M., C.O.V. and C.O.L." section.

OPTIONS

California TB133 Fire Safety Code

The above seating products can be manufactured using the appropriate flame-retardant materials for compliance to California Technical Bulletin 133. Add "FR" to end of model number.
 Model=Polypropylene
 Added Lead Time=none
 Added List Price=\$19
 Model=Upholstered Seat Only
 Added Lead Time=none
 Added List Price=\$30

SPECIAL SERVICES

Special Carton Marking

With specially marked information N/C



Shipping

Shipped **assembled freight prepaid f.o.b. Green Bay, Wisconsin 54302** factory. Freight class #125.

Specifications and prices are subject to change without prior notice.

Ruckus™ Seating (Delivered Pricing)

Stack Chair with Casters

	MODEL	Features	H	MODEL NUMBER					
				Basic Model	Fire Code	Poly Color	Frame Color	Caster Type	Upholstery Color
 <p>RKV1</p>	Stack Chair with Casters • Ships fully assembled, packaged 2 chairs per carton • 15" chair stacks 3 high • 18" chair stacks 4 high	Polypropylene	15"	RKV100H15NB	<input type="checkbox"/> <input type="checkbox"/> <input type="checkbox"/>	<input type="checkbox"/> <input type="checkbox"/> <input type="checkbox"/>	<input type="checkbox"/> <input type="checkbox"/>	<input type="checkbox"/> <input type="checkbox"/> <input type="checkbox"/>	
		Polypropylene	18"	RKV100H18NB	<input type="checkbox"/> <input type="checkbox"/> <input type="checkbox"/>	<input type="checkbox"/> <input type="checkbox"/> <input type="checkbox"/>	<input type="checkbox"/> <input type="checkbox"/>	<input type="checkbox"/> <input type="checkbox"/> <input type="checkbox"/>	
 <p>RKV2</p>	Stack Chair with Casters • Ships fully assembled, packaged 1 chair per carton • 15" chair stacks 2 high • 18" chair stacks 3 high	Upholstered Seat	15"	RKV200H15NB	<input type="checkbox"/> <input type="checkbox"/> <input type="checkbox"/>	<input type="checkbox"/> <input type="checkbox"/> <input type="checkbox"/>	<input type="checkbox"/> <input type="checkbox"/>	<input type="checkbox"/> <input type="checkbox"/> <input type="checkbox"/> <input type="checkbox"/>	
		Upholstered Seat	18"	RKV200H18NB	<input type="checkbox"/> <input type="checkbox"/> <input type="checkbox"/>	<input type="checkbox"/> <input type="checkbox"/> <input type="checkbox"/>	<input type="checkbox"/> <input type="checkbox"/>	<input type="checkbox"/> <input type="checkbox"/> <input type="checkbox"/> <input type="checkbox"/>	

A
B
C
D
E
F

HOW TO ORDER

Indicate the following information on order form:

- Quantity of each item.
- Model number, including options. See "How To Build a Model Number".
- Any special service required.

Note: • The indicates that a choice is required.

- The absence of the indicates that no choice is required.
- Alpha-numeric characters in place of indicate that no other alternatives are available.

HOW TO BUILD A MODEL NUMBER

- A** Select basic model.
- B** Select fire retardant.

NFR	- Compliance to TB 117-2013
FR	- Compliance to TB 133
- C** Select poly color.
Refer to color addendum at ki.com or KI Fabrics & Finishes binder.
- D** Select frame finish.
Refer to color addendum at ki.com or KI Fabrics & Finishes binder.
- E** Select caster type.

CHC	- Hard floor casters
CCC	- Carpet casters
- F** Select upholstery grade/color.
Refer to color addendum at ki.com or KI Fabrics & Finishes binder.



Ruckus™ Seating (Delivered Pricing)

Stack Chair with Casters

Approx. Packaged Weight	Delivered Pricing Unupholstered	Delivered Pricing Fabric Grade 1 & C.O.M.	Delivered Pricing Fabric Grade 2	Delivered Pricing Fabric Grade 3 & Group 2V Vinyl	Delivered Pricing C.O.V.	Delivered Pricing Pallas Fabric Group P0	Delivered Pricing Pallas Fabric Group P1	Delivered Pricing Pallas Fabric Group P2	Delivered Pricing Pallas Fabric Group P3	Delivered Pricing Pallas Fabric Group P4
34.5#	\$ 249									
35.5#	252									
37.0#	N/A	\$ 350	\$ 358	\$ 373	\$ 350	\$ 381	\$ 427	\$ 441	\$ 459	\$ 485
38.0#	N/A	353	361	376	353	384	430	444	462	488

UPHOLSTERY INFORMATION

C.O.M. Upholstery

C.O.M. requirement for 10 chairs or less with upholstered seat or upholstered seat and back is 3/4 yard per chair of 54" wide nondirectional fabric. For orders of 11 or more with upholstered seat and back and for complete information on ordering C.O.M. see "Ordering C.O.M., C.O.V. and C.O.L." section.

OPTIONS

California TB133 Fire Safety Code

The above seating products can be manufactured using the appropriate flame-retardant materials for compliance to California Technical Bulletin 133. Add "FR" to end of model number.
 Model=Polypropylene
 Added Lead Time=none
 Added List Price=\$19
 Model=Upholstered Seat Only
 Added Lead Time=none
 Added List Price=\$30

SPECIAL SERVICES

Special Carton Marking

With specially marked information N/C



Shipping

Shipped **assembled freight prepaid f.o.b. Green Bay, Wisconsin 54302** factory. Freight class #125.

Specifications and prices are subject to change without prior notice.

Ruckus™ Seating (Delivered Pricing)

Stack Chair with Casters

	MODEL	Features	H	MODEL NUMBER						
				Basic Model	Fire Code	Poly Color	Frame Color	Bookrack Color	Caster Type	Upholstery Color
	Stack Chair with Casters and Bookrack • Ships fully assembled, packaged 2 chairs per carton • 15" chair stacks 3 high • 18" chair stacks 4 high	Polypropylene	15"	RKV100H15BR	<input type="checkbox"/> <input type="checkbox"/> <input type="checkbox"/>	<input type="checkbox"/> <input type="checkbox"/> <input type="checkbox"/>	<input type="checkbox"/>	<input type="checkbox"/> <input type="checkbox"/> <input type="checkbox"/> <input type="checkbox"/>	<input type="checkbox"/> <input type="checkbox"/>	
		Polypropylene	18"	RKV100H18BR	<input type="checkbox"/> <input type="checkbox"/> <input type="checkbox"/>	<input type="checkbox"/> <input type="checkbox"/> <input type="checkbox"/>	<input type="checkbox"/>	<input type="checkbox"/> <input type="checkbox"/> <input type="checkbox"/> <input type="checkbox"/>	<input type="checkbox"/> <input type="checkbox"/>	
RKV1										
	Stack Chair with Casters and Bookrack • Ships fully assembled, packaged 1 chair per carton • 15" chair stacks 2 high • 18" chair stacks 3 high	Upholstered Seat	15"	RKV200H15BR	<input type="checkbox"/> <input type="checkbox"/> <input type="checkbox"/>	<input type="checkbox"/> <input type="checkbox"/> <input type="checkbox"/>	<input type="checkbox"/>	<input type="checkbox"/> <input type="checkbox"/> <input type="checkbox"/> <input type="checkbox"/>	<input type="checkbox"/> <input type="checkbox"/>	<input type="checkbox"/> <input type="checkbox"/> <input type="checkbox"/> <input type="checkbox"/>
		Upholstered Seat	18"	RKV200H18BR	<input type="checkbox"/> <input type="checkbox"/> <input type="checkbox"/>	<input type="checkbox"/> <input type="checkbox"/> <input type="checkbox"/>	<input type="checkbox"/>	<input type="checkbox"/> <input type="checkbox"/> <input type="checkbox"/> <input type="checkbox"/>	<input type="checkbox"/> <input type="checkbox"/>	<input type="checkbox"/> <input type="checkbox"/> <input type="checkbox"/> <input type="checkbox"/>
RKV2										

A **B** **C** **D** **E** **F** **G**

HOW TO ORDER

Indicate the following information on order form:

- Quantity of each item.
- Model number, including options. See "How To Build a Model Number".
- Any special service required.

Note: • The indicates that a choice is required.

- The absence of the indicates that no choice is required.
- Alpha-numeric characters in place of indicate that no other alternatives are available.

HOW TO BUILD A MODEL NUMBER

Refer to color addendum at ki.com or KI Fabrics & Finishes binder.

- A** Select basic model.
- B** Select fire retardant.

NFR	- Compliance to TB 117-2013
FR	- Compliance to TB 133
- C** Select poly color.
Refer to color addendum at ki.com or KI Fabrics & Finishes binder.
- D** Select frame finish.
Refer to color addendum at ki.com or KI Fabrics & Finishes binder.
- E** Select bookrack color.
Refer to color addendum at ki.com or KI Fabrics & Finishes binder.
- F** Select caster type.

CHC	- Hard floor casters
CCC	- Carpet casters
- G** Select upholstery grade/color.



Ruckus™ Seating (Delivered Pricing)

Stack Chair with Casters

Approx. Packaged Weight	Delivered Pricing Unupholstered	Delivered Pricing Fabric Grade 1 & C.O.M.	Delivered Pricing Fabric Grade 2	Delivered Pricing Fabric Grade 3 & Group 2V Vinyl	Delivered Pricing C.O.V.	Delivered Pricing Pallas Fabric Group P0	Delivered Pricing Pallas Fabric Group P1	Delivered Pricing Pallas Fabric Group P2	Delivered Pricing Pallas Fabric Group P3	Delivered Pricing Pallas Fabric Group P4
37.5#	\$ 300									
38.5#	304									
40.0#	N/A	\$ 402	\$ 410	\$ 425	\$ 402	\$ 433	\$ 479	\$ 493	\$ 511	\$ 537
41.0#	N/A	405	413	428	405	436	482	496	514	540

UPHOLSTERY INFORMATION

C.O.M. Upholstery

C.O.M. requirement for 10 chairs or less with upholstered seat or upholstered seat and back is 3/4 yard per chair of 54" wide nondirectional fabric. For orders of 11 or more with upholstered seat and back and for complete information on ordering C.O.M. see "Ordering C.O.M., C.O.V. and C.O.L." section.

OPTIONS

California TB133 Fire Safety Code

The above seating products can be manufactured using the appropriate flame-retardant materials for compliance to California Technical Bulletin 133. Add "FR" to end of model number.
 Model=Polypropylene
 Added Lead Time=none
 Added List Price=\$19
 Model=Upholstered Seat Only
 Added Lead Time=none
 Added List Price=\$30

SPECIAL SERVICES

Special Carton Marking

With specially marked information N/C



Shipping

Shipped **assembled freight prepaid f.o.b. Green Bay, Wisconsin 54302** factory. Freight class #125.

Specifications and prices are subject to change without prior notice.

Ruckus™ Seating (Delivered Pricing)

Stools

	MODEL	Features	H	MODEL NUMBER					
				Basic Model	Fire Code	Poly Color	Frame Color	Glide Option	Upholstery Color
 <p>RK41</p>	Stool No Bookrack	Polypropylene	24"	RK4100H24NB	<input type="checkbox"/> <input type="checkbox"/> <input type="checkbox"/>	<input type="checkbox"/> <input type="checkbox"/> <input type="checkbox"/>	<input type="checkbox"/> <input type="checkbox"/>	<input type="checkbox"/> <input type="checkbox"/> <input type="checkbox"/>	
		• Casters not available on stool models	Polypropylene	30"	RK4100H30NB	<input type="checkbox"/> <input type="checkbox"/> <input type="checkbox"/>	<input type="checkbox"/> <input type="checkbox"/> <input type="checkbox"/>	<input type="checkbox"/> <input type="checkbox"/>	<input type="checkbox"/> <input type="checkbox"/> <input type="checkbox"/>
	• Ships fully assembled, packaged 1 chair per carton								
	• Stacks 3 high								
 <p>RK42</p>	Stool No Bookrack	Upholstered Seat	24"	RK4200H24NB	<input type="checkbox"/> <input type="checkbox"/> <input type="checkbox"/>	<input type="checkbox"/> <input type="checkbox"/> <input type="checkbox"/>	<input type="checkbox"/> <input type="checkbox"/>	<input type="checkbox"/> <input type="checkbox"/> <input type="checkbox"/>	<input type="checkbox"/> <input type="checkbox"/> <input type="checkbox"/> <input type="checkbox"/>
		• Casters not available on stool models	Upholstered Seat	30"	RK4200H30NB	<input type="checkbox"/> <input type="checkbox"/> <input type="checkbox"/>	<input type="checkbox"/> <input type="checkbox"/> <input type="checkbox"/>	<input type="checkbox"/> <input type="checkbox"/>	<input type="checkbox"/> <input type="checkbox"/> <input type="checkbox"/>
	• Ships fully assembled, packaged 1 chair per carton								
	• Stacks 3 high								

A **B** **C** **D** **E** **F**

HOW TO ORDER

Indicate the following information on order form:

1. Quantity of each item.
2. Model number, including options. See "How To Build a Model Number".
3. Any special service required.

Note: • The indicates that a choice is required.

- The absence of the indicates that no choice is required.
- Alpha-numeric characters in place of indicate that no other alternatives are available.

HOW TO BUILD A MODEL NUMBER

- A** Select basic model.
- B** Select fire retardant.

NFR	- Compliance to TB 117-2013
FR	- Compliance to TB 133
- C** Select poly color. Refer to color addendum at ki.com or KI Fabrics & Finishes binder.
- D** Select frame finish. Refer to color addendum at ki.com or KI Fabrics & Finishes binder.
- E** Select glide option.

GFT	- Felt glides
GPL	- Nylon plastic glides
GSL	- Steel glides
- F** Select upholstery grade/color. Refer to color addendum at ki.com or KI Fabrics & Finishes binder.



Ruckus™ Seating (Delivered Pricing)

Stools

Approx. Packaged Weight	Delivered Pricing Unupholstered	Delivered Pricing Fabric Grade 1 & C.O.M.	Delivered Pricing Fabric Grade 2	Delivered Pricing Fabric Grade 3 & Group 2V Vinyl	Delivered Pricing C.O.V.	Delivered Pricing Pallas Fabric Group P0	Delivered Pricing Pallas Fabric Group P1	Delivered Pricing Pallas Fabric Group P2	Delivered Pricing Pallas Fabric Group P3	Delivered Pricing Pallas Fabric Group P4
42.0#	\$ 282									
43.0#	292									
44.5#	N/A	\$ 383	\$ 391	\$ 406	\$ 383	\$ 414	\$ 460	\$ 474	\$ 492	\$ 518
45.5#	N/A	393	401	416	393	424	470	484	502	528

UPHOLSTERY INFORMATION

C.O.M. Upholstery

C.O.M. requirement for 10 chairs or less with upholstered seat or upholstered seat and back is 3/4 yard per chair of 54" wide nondirectional fabric. For orders of 11 or more with upholstered seat and back and for complete information on ordering C.O.M. see "Ordering C.O.M., C.O.V. and C.O.L." section.

OPTIONS

California TB133 Fire Safety Code

The above seating products can be manufactured using the appropriate flame-retardant materials for compliance to California Technical Bulletin 133. Add "FR" to end of model number.
 Model=Polypropylene
 Added Lead Time=none
 Added List Price=\$19
 Model=Upholstered Seat Only
 Added Lead Time=none
 Added List Price=\$30

SPECIAL SERVICES

Special Carton Marking

With specially marked information N/C



Shipping

Shipped **assembled f.o.b. Green Bay, Wisconsin 54302** factory. Freight class #125.

Specifications and prices are subject to change without prior notice.

Ruckus™ Seating (Delivered Pricing)

Stools

	MODEL	Features	H	MODEL NUMBER							
				Basic Model	Fire Code	Poly Color	Frame Color	Bookrack Color	Glide Option	Upholstery Color	
 <p>RK41</p>	Stool with Bookrack	Polypropylene	24"	RK4100H24BR	<input type="checkbox"/> <input type="checkbox"/> <input type="checkbox"/>	<input type="checkbox"/> <input type="checkbox"/> <input type="checkbox"/>	<input type="checkbox"/>	<input type="checkbox"/> <input type="checkbox"/> <input type="checkbox"/> <input type="checkbox"/>	<input type="checkbox"/> <input type="checkbox"/> <input type="checkbox"/>		
		• Casters not available on stool models									
		• Ships fully assembled, packaged 1 chair per carton	Polypropylene	30"	RK4100H30BR	<input type="checkbox"/> <input type="checkbox"/> <input type="checkbox"/>	<input type="checkbox"/> <input type="checkbox"/> <input type="checkbox"/>	<input type="checkbox"/>	<input type="checkbox"/> <input type="checkbox"/> <input type="checkbox"/> <input type="checkbox"/>	<input type="checkbox"/> <input type="checkbox"/> <input type="checkbox"/>	
		• Stacks 3 high									
 <p>RK42</p>	Stool with Bookrack	Upholstered Seat	24"	RK4200H24BR	<input type="checkbox"/> <input type="checkbox"/> <input type="checkbox"/>	<input type="checkbox"/> <input type="checkbox"/> <input type="checkbox"/>	<input type="checkbox"/>	<input type="checkbox"/> <input type="checkbox"/> <input type="checkbox"/> <input type="checkbox"/>	<input type="checkbox"/> <input type="checkbox"/> <input type="checkbox"/>	<input type="checkbox"/> <input type="checkbox"/> <input type="checkbox"/> <input type="checkbox"/>	
		• Casters not available on stool models									
		• Ships fully assembled, packaged 1 chair per carton	Upholstered Seat	30"	RK4200H30BR	<input type="checkbox"/> <input type="checkbox"/> <input type="checkbox"/>	<input type="checkbox"/> <input type="checkbox"/> <input type="checkbox"/>	<input type="checkbox"/>	<input type="checkbox"/> <input type="checkbox"/> <input type="checkbox"/> <input type="checkbox"/>	<input type="checkbox"/> <input type="checkbox"/> <input type="checkbox"/>	<input type="checkbox"/> <input type="checkbox"/> <input type="checkbox"/> <input type="checkbox"/>
		• Stacks 3 high									
					A	B	C	D	E	F	G

HOW TO ORDER

Indicate the following information on order form:

- Quantity of each item.
- Model number, including options. See "How To Build a Model Number".
- Any special service required.

Note: • The indicates that a choice is required.

- The absence of the indicates that no choice is required.
- Alpha-numeric characters in place of indicate that no other alternatives are available.

HOW TO BUILD A MODEL NUMBER

- A** Select basic model.
- B** Select fire retardant.

NFR	- Compliance to TB 117-2013
FR	- Compliance to TB 133
- C** Select poly color. Refer to color addendum at ki.com or KI Fabrics & Finishes binder.
- D** Select frame finish. Refer to color addendum at ki.com or KI Fabrics & Finishes binder.
- E** Select bookrack color. Refer to color addendum at ki.com or KI Fabrics & Finishes binder.
- F** Select glide option.

GFT	- Felt glides
GPL	- Nylon plastic glides
GSL	- Steel glides

- G** Select upholstery grade/color. Refer to color addendum at ki.com or KI Fabrics & Finishes binder.



Ruckus™ Seating (Delivered Pricing)

Stools

Approx. Packaged Weight	Delivered Pricing Unupholstered	Delivered Pricing Fabric Grade 1 & C.O.M.	Delivered Pricing Fabric Grade 2	Delivered Pricing Fabric Grade 3 & Group 2V Vinyl	Delivered Pricing C.O.V.	Delivered Pricing Pallas Fabric Group P0	Delivered Pricing Pallas Fabric Group P1	Delivered Pricing Pallas Fabric Group P2	Delivered Pricing Pallas Fabric Group P3	Delivered Pricing Pallas Fabric Group P4
45.0#	\$ 333									
46.0#	343									
47.5#	N/A	\$ 435	\$ 443	\$ 458	\$ 435	\$ 466	\$ 512	\$ 526	\$ 544	\$ 570
48.5#	N/A	444	452	467	444	475	521	535	553	579

UPHOLSTERY INFORMATION

C.O.M. Upholstery

C.O.M. requirement for 10 chairs or less with upholstered seat or upholstered seat and back is 3/4 yard per chair of 54" wide nondirectional fabric. For orders of 11 or more with upholstered seat and back and for complete information on ordering C.O.M. see "Ordering C.O.M., C.O.V. and C.O.L." section.

OPTIONS

California TB133 Fire Safety Code

The above seating products can be manufactured using the appropriate flame-retardant materials for compliance to California Technical Bulletin 133. Add "FR" to end of model number.
 Model=Polypropylene
 Added Lead Time=none
 Added List Price=\$19
 Model=Upholstered Seat Only
 Added Lead Time=none
 Added List Price=\$30

SPECIAL SERVICES

Special Carton Marking

With specially marked information N/C



Shipping

Shipped **assembled freight prepaid f.o.b. Green Bay, Wisconsin 54302** factory. Freight class #125.

Specifications and prices are subject to change without prior notice.

Ruckus™ Seating (Delivered Pricing)

Task Chair

	MODEL	Features	MODEL NUMBER						Approx. Packaged Weight	
			Basic Model	Fire Code	Poly Color	Frame Color	Caster Type	Upholstery Color		
 RK51	Task Chair • Ships KD, packaged 1 chair per carton • Utilizes 28" 5-blade base	Polypropylene	RK5100	<input type="checkbox"/> <input type="checkbox"/>	<input type="checkbox"/> <input type="checkbox"/>	<input type="checkbox"/>	<input type="checkbox"/> <input type="checkbox"/>		36.0#	
 RK52	Task Chair • Ships KD, packaged 1 chair per carton • Utilizes 28" 5-blade base	Upholstered Seat	RK5200	<input type="checkbox"/> <input type="checkbox"/>	<input type="checkbox"/> <input type="checkbox"/>	<input type="checkbox"/>	<input type="checkbox"/> <input type="checkbox"/>	<input type="checkbox"/> <input type="checkbox"/> <input type="checkbox"/> <input type="checkbox"/>	38.5#	

A **B** **C** **D** **E** **F**

HOW TO ORDER

Indicate the following information on order form:

- Quantity of each item.
- Model number, including options. See "How To Build a Model Number".
- Any special service required.

Note: • The indicates that a choice is required.

- The absence of the indicates that no choice is required.
- Alpha-numeric characters in place of indicate that no other alternatives are available.

HOW TO BUILD A MODEL NUMBER

- A** Select basic model.
- B** Select fire retardant.
NFR - Compliance to TB 117-2013
FR - Compliance to TB 133
- C** Select poly color.
 Refer to color addendum at ki.com or KI Fabrics & Finishes binder.
- D** Select frame color.
 Refer to color addendum at ki.com or KI Fabrics & Finishes binder.
- E** Select caster or glide type.
CHC - Hard floor casters
CCC - Carpet casters
GBG - Bell glide
- F** Select upholstery grade/color.
 Refer to color addendum at ki.com or KI Fabrics & Finishes binder.



Ruckus™ Seating (Delivered Pricing)

Task Chair

Delivered Pricing Unupholstered	Delivered Pricing Fabric Grade 1 & C.O.M.	Delivered Pricing Fabric Grade 2	Delivered Pricing Fabric Grade 3 & Group 2V Vinyl	Delivered Pricing C.O.V.	Delivered Pricing Pallas Fabric Group P0	Delivered Pricing Pallas Fabric Group P1	Delivered Pricing Pallas Fabric Group P2	Delivered Pricing Pallas Fabric Group P3	Delivered Pricing Pallas Fabric Group P4
\$ 302									
N/A	\$ 403	\$ 411	\$ 426	\$ 403	\$ 434	\$ 480	\$ 494	\$ 512	\$ 538

UPHOLSTERY INFORMATION

C.O.M. Upholstery

C.O.M. requirement for 10 chairs or less with upholstered seat or upholstered seat and back is 3/4 yard per chair of 54" wide nondirectional fabric. For orders of 11 or more with upholstered seat and back and for complete information on ordering C.O.M. see "Ordering C.O.M., C.O.V. and C.O.L." section.

OPTIONS

California TB133 Fire Safety Code

The above seating products can be manufactured using the appropriate flame-retardant materials for compliance to California Technical Bulletin 133. Add "FR" to end of model number.
 Model=Polypropylene
 Added Lead Time=none
 Added List Price=\$19
 Model=Upholstered Seat Only
 Added Lead Time=none
 Added List Price=\$30

SPECIAL SERVICES

Special Carton Marking

With specially marked information N/C

Shipping

Shipped **k.d.f.o.b. Green Bay, Wisconsin 54302** factory. Freight class #125.

Specifications and prices are subject to change without prior notice.

Ruckus™ Desking (Delivered Pricing)

Desk

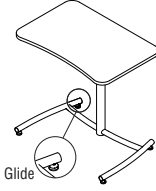
MODEL	Features	MODEL NUMBER						Approx. Packaged Weight	
		Basic Model	Storage Accessories	Base	Top Color	Edge Color	Base Color		
 <p>RU420</p>	Fixed Height - Glide Base • Laminate curved front only • 20" x 30" worksurface • Ships fully assembled, packaged 1 desk per carton	26" High	RU4207	<input type="checkbox"/> <input type="checkbox"/> <input type="checkbox"/> <input type="checkbox"/>	<input type="checkbox"/> <input type="checkbox"/>	<input type="checkbox"/> <input type="checkbox"/> <input type="checkbox"/> <input type="checkbox"/>	<input type="checkbox"/> <input type="checkbox"/>	<input type="checkbox"/> <input type="checkbox"/>	37.0#
	29" High	RU4201	<input type="checkbox"/> <input type="checkbox"/> <input type="checkbox"/> <input type="checkbox"/>	<input type="checkbox"/> <input type="checkbox"/>	<input type="checkbox"/> <input type="checkbox"/> <input type="checkbox"/> <input type="checkbox"/>	<input type="checkbox"/> <input type="checkbox"/>	<input type="checkbox"/> <input type="checkbox"/>	39.0#	

A **B** **C** **D** **E** **F**

HOW TO ORDER

Indicate the following information on order form:

- Quantity of each item.
- Model number, including options. See "How To Build a Model Number".
- Any special service required.

Note: • The indicates that a choice is required.

- The absence of the indicates that no choice is required.
- Alpha-numeric characters in place of indicate that no other alternatives are available.

HOW TO BUILD A MODEL NUMBER

- A** Select basic model.
- B** Select storage/accessories.

BH	- Book bag hook; add \$8
NB	- No book storage
- C** Select base option.

GFT	- Felt glides
GPL	- Nylon plastic glides
GSL	- Steel glides
- D** Select top laminate surface.
Refer to color addendum at ki.com or KI Fabrics & Finishes binder.
- E** Select edge color.
Refer to color addendum at ki.com or KI Fabrics & Finishes binder.
- F** Select base color.
Refer to color addendum at ki.com or KI Fabrics & Finishes binder.

FINISH INFORMATION

Additional Laminate Offering

Additional laminates beyond KI standard offering, are available with two weeks extended leadtime. To specify additional laminates, use these designators followed by the supplier's color/pattern code:

Formica - LF/supplier's color pattern code
 Nevamar - LN/supplier's color pattern code
 Wilsonart - LW/supplier's color pattern code

KI's standard finish is the supplier's recommended finish for that color/pattern. Note: Nonstandard laminates from these suppliers (example: textured laminates), require an upcharge and additional leadtime. Contact KI.



Ruckus™ Desking (Delivered Pricing)

Desk

Delivered
Pricing

\$ 445

450

SPECIAL SERVICES

Special Carton Marking

With specially marked information N/C

Shipping

Shipped **assembled freight prepaid f.o.b.**
Green Bay, Wisconsin 54302 factory.
Freight class #125.

Specifications and prices are subject to
change without prior notice.

Ruckus™ Desking (Delivered Pricing)

Desk

MODEL	Features	MODEL NUMBER						Approx. Packaged Weight
		Basic Model	Storage Accessories	Base	Top Color	Edge Color	Base Color	
 <p>Wheelbarrow</p> <p>Fixed Height - Rolling Base</p> <ul style="list-style-type: none"> Laminate curved front only 20" x 30" worksurface Ships fully assembled, packaged 1 desk per carton 	26" High	RU5207	<input type="checkbox"/> <input type="checkbox"/> <input type="checkbox"/> <input type="checkbox"/>	<input type="checkbox"/> <input type="checkbox"/>	<input type="checkbox"/> <input type="checkbox"/> <input type="checkbox"/>	<input type="checkbox"/> <input type="checkbox"/>	<input type="checkbox"/> <input type="checkbox"/>	37.0#
	29" High	RU5201	<input type="checkbox"/> <input type="checkbox"/> <input type="checkbox"/> <input type="checkbox"/>	<input type="checkbox"/> <input type="checkbox"/>	<input type="checkbox"/> <input type="checkbox"/> <input type="checkbox"/>	<input type="checkbox"/> <input type="checkbox"/>	<input type="checkbox"/> <input type="checkbox"/>	<input type="checkbox"/> <input type="checkbox"/>

RU520

A **B** **C** **D** **E** **F**

HOW TO ORDER

Indicate the following information on order form:

- Quantity of each item.
- Model number, including options. See "How To Build a Model Number".
- Any special service required.

Note:

- The indicates that a choice is required.
- The absence of the indicates that no choice is required.
- Alpha-numeric characters in place of indicate that no other alternatives are available.

HOW TO BUILD A MODEL NUMBER

Refer to color addendum at ki.com or KI Fabrics & Finishes binder.

- A** Select basic model.
- B** Select storage/accessories.
 - BH** - Book bag hook; add \$8
 - NB** - No book storage
- C** Select base option.
 - RPL** - Wheelbarrow (roller front, plastic glides back)
 - RFT** - Wheelbarrow (rolling front, felt solo glides back)
 - RSL** - Wheelbarrow (rolling front, steel glides back)
- D** Select top laminate surface. Refer to color addendum at ki.com or KI Fabrics & Finishes binder.
- E** Select edge color. Refer to color addendum at ki.com or KI Fabrics & Finishes binder.
- F** Select base color.

FINISH INFORMATION

Additional Laminate Offering

Additional laminates beyond KI standard offering, are available with two weeks extended leadtime. To specify additional laminates, use these designators followed by the supplier's color/pattern code:

Formica - LF/supplier's color pattern code
 Nevamar - LN/supplier's color pattern code
 Wilsonart - LW/supplier's color pattern code

KI's standard finish is the supplier's recommended finish for that color/pattern. Note: Nonstandard laminates from these suppliers (example: textured laminates), require an upcharge and additional leadtime. Contact KI.



Ruckus™ Desking (Delivered Pricing)

Desk

Delivered
Pricing

\$ 475

480

SPECIAL SERVICES

Special Carton Marking

With specially marked information N/C



Shipping

Shipped **assembled freight prepaid f.o.b.**
Green Bay, Wisconsin 54302 factory.
Freight class #125.

Specifications and prices are subject to
change without prior notice.

Ruckus™ Storage (Delivered Pricing)

Lockers

	MODEL	W x D x H	MODEL NUMBER					Approx. Packaged Weight
			Basic Model	Base	Top Color	Edge Color	Shell Color	
	Locker-Two Open Units • Laminate top (1-1/4" with 74P edge) • Dual sided storage (4 compartments total) • 2 hooks per opening • Unit ships assembled; glides/casters are field installed	36x24x36	RKL362436OP	<input type="checkbox"/> <input type="checkbox"/>	<input type="checkbox"/> <input type="checkbox"/>	<input type="checkbox"/> <input type="checkbox"/>	<input type="checkbox"/> <input type="checkbox"/>	165.3#
		36x24x42	RKL362442OP	<input type="checkbox"/> <input type="checkbox"/>	<input type="checkbox"/> <input type="checkbox"/>	<input type="checkbox"/> <input type="checkbox"/>	<input type="checkbox"/> <input type="checkbox"/>	178.5#
RCKL								
	Locker-Three Open Units • Laminate top (1-1/4" with 74P edge) • Dual sided storage (6 compartments total) • 2 hooks per opening • Unit ships assembled; glides/casters are field installed	54x24x36	RKL542436OP	<input type="checkbox"/> <input type="checkbox"/>	<input type="checkbox"/> <input type="checkbox"/>	<input type="checkbox"/> <input type="checkbox"/>	<input type="checkbox"/> <input type="checkbox"/>	211.0#
		54x24x42	RKL542442OP	<input type="checkbox"/> <input type="checkbox"/>	<input type="checkbox"/> <input type="checkbox"/>	<input type="checkbox"/> <input type="checkbox"/>	<input type="checkbox"/> <input type="checkbox"/>	229.0#
RCKL								
				A	B	C	D	E

HOW TO ORDER

Indicate the following information on order form:

- Quantity of each item.
- Model number, including options. See "How To Build a Model Number".
- Any special service required.

Note: • The indicates that a choice is required.

- The absence of the indicates that no choice is required.
- Alpha-numeric characters in place of indicate that no other alternatives are available.

HOW TO BUILD A MODEL NUMBER

- A** Select basic model.
- B** Select base option.
- | | |
|------------|-------------------|
| 4CW | - 4 black casters |
| 4GB | - 4 black glides |
- C** Select top laminate surface.
Refer to color addendum at ki.com or KI Fabrics & Finishes binder.
- D** Select edge color.
Refer to color addendum at ki.com or KI Fabrics & Finishes binder.
- E** Select shell color.
Refer to color addendum at ki.com or KI Fabrics & Finishes binder.

FINISH INFORMATION

Additional Laminate Offering

Additional laminates beyond KI standard offering, are available with two weeks extended leadtime. To specify additional laminates, use these designators followed by the supplier's color/pattern code:

Formica - LF/supplier's color pattern code
 Nevamar - LN/supplier's color pattern code
 Wilsonart - LW/supplier's color pattern code

KI's standard finish is the supplier's recommended finish for that color/pattern. Note: Nonstandard laminates from these suppliers (example: textured laminates), require an upcharge and additional leadtime. Contact KI.



Ruckus™ Storage (Delivered Pricing)

Lockers

Delivered Pricing

\$ 1012

1050

\$ 1310

1360

SPECIAL SERVICES

Special Carton Marking

With specially marked information N/C



Shipping

Shipped **assembled freight prepaid f.o.b. Pembroke, Ontario K8A 0E1** factory. Freight class #100.

Specifications and prices are subject to change without prior notice.

Ruckus™ Storage (Delivered Pricing)

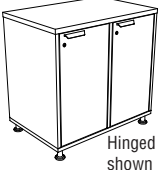
Lockers

	W x D x H	MODEL NUMBER									Approx. Packaged Weight
		Basic Model	Door Lock Option	Pull Option	Base	Top Color	Edge Color	Shell Color	Door Color	Lock Option	
 <p>Hinged right shown</p>	36x24x36	RKL362436DR	<input type="checkbox"/> <input type="checkbox"/> <input type="checkbox"/> <input type="checkbox"/>	<input type="checkbox"/> <input type="checkbox"/>	<input type="checkbox"/> <input type="checkbox"/>	<input type="checkbox"/> <input type="checkbox"/>	<input type="checkbox"/> <input type="checkbox"/>	<input type="checkbox"/> <input type="checkbox"/>	<input type="checkbox"/> <input type="checkbox"/>	<input type="checkbox"/> <input type="checkbox"/>	192.1#
	36x24x42	RKL362442DR	<input type="checkbox"/> <input type="checkbox"/> <input type="checkbox"/> <input type="checkbox"/>	<input type="checkbox"/> <input type="checkbox"/>	<input type="checkbox"/> <input type="checkbox"/>	<input type="checkbox"/> <input type="checkbox"/>	<input type="checkbox"/> <input type="checkbox"/>	<input type="checkbox"/> <input type="checkbox"/>	<input type="checkbox"/> <input type="checkbox"/>	<input type="checkbox"/> <input type="checkbox"/>	<input type="checkbox"/> <input type="checkbox"/>
<p>RCKL</p> <p>Locker-Two Door Units</p> <ul style="list-style-type: none"> Laminate top (1-1/4" with 74P edge) Dual sided storage (4 compartments total) Secure locking doors 4 locking options offered Unit ships assembled; glides/casters are field installed 											
 <p>Hinged right shown</p>	54x24x36	RKL542436DR	<input type="checkbox"/> <input type="checkbox"/> <input type="checkbox"/> <input type="checkbox"/>	<input type="checkbox"/> <input type="checkbox"/>	<input type="checkbox"/> <input type="checkbox"/>	<input type="checkbox"/> <input type="checkbox"/>	<input type="checkbox"/> <input type="checkbox"/>	<input type="checkbox"/> <input type="checkbox"/>	<input type="checkbox"/> <input type="checkbox"/>	<input type="checkbox"/> <input type="checkbox"/>	251.2#
	54x24x42	RKL542442DR	<input type="checkbox"/> <input type="checkbox"/> <input type="checkbox"/> <input type="checkbox"/>	<input type="checkbox"/> <input type="checkbox"/>	<input type="checkbox"/> <input type="checkbox"/>	<input type="checkbox"/> <input type="checkbox"/>	<input type="checkbox"/> <input type="checkbox"/>	<input type="checkbox"/> <input type="checkbox"/>	<input type="checkbox"/> <input type="checkbox"/>	<input type="checkbox"/> <input type="checkbox"/>	<input type="checkbox"/> <input type="checkbox"/>
<p>RCKL</p> <p>Locker-Three Door Units</p> <ul style="list-style-type: none"> Laminate top (1-1/4" with 74P edge) Dual sided storage (6 compartments total) Secure locking doors 4 locking options offered Unit ships assembled; glides/casters are field installed 											

A B C D E F G H I

HOW TO ORDER

Indicate the following information on order form:

- Quantity of each item.
- Model number, including options. See "How To Build a Model Number".
- Any special service required.

Note: • The indicates that a choice is required.

- The absence of the indicates that no choice is required.
- Alpha-numeric characters in place of indicate that no other alternatives are available.

HOW TO BUILD A MODEL NUMBER

- A** Select basic model.
- B** Select door lock option.
 - SLCKL** - Standard lock hinged left
 - SLCKR** - Standard lock hinged right
 - PLCKL** - Padlock hinged left
 - PLCKR** - Padlock hinged right
 - CLCKL** - Combination lock hinged left
 - CLCKR** - Combination lock hinged right
 - DLCKL** - Digital lock hinged left
 - DLCKR** - Digital lock hinged right
- C** Select pull option.
 - S6** - Beveled pull Black
 - S5** - Beveled pull Satin Chrome
 Pull selection only when SLCKR or SLCKL key lock is selected.
- D** Select base option.
 - 4CW** - 4 black casters
 - 4GB** - 4 black glides

- E** Select top laminate surface. Refer to color addendum at ki.com or KI Fabrics & Finishes binder.
- F** Select edge color. Refer to color addendum at ki.com or KI Fabrics & Finishes binder.
- G** Select shell color. Refer to color addendum at ki.com or KI Fabrics & Finishes binder.
- H** Select front door color. Refer to color addendum at ki.com or KI Fabrics & Finishes binder.
- I** Select lock option
 - KA** - Key alike
 - KS** - Key standard
 - NLC** - No lock core
 Available ONLY when the standard lock is selected.

FINISH INFORMATION

Additional Laminate Offering

Additional laminates beyond KI standard offering, are available with two weeks extended leadtime. To specify additional laminates, use these designators followed by the supplier's color/pattern code:

Formica - LF/supplier's color pattern code
 Nevamar - LN/supplier's color pattern code
 Wilsonart - LW/supplier's color pattern code

KI's standard finish is the supplier's recommended finish for that color/pattern. Note: Nonstandard laminates from these suppliers (example: textured laminates), require an upcharge and additional leadtime. Contact KI.

Ruckus™ Storage (Delivered Pricing)

Bookcase

MODEL	W x D x H	MODEL NUMBER					Approx. Packaged Weight
		Basic Model	Base	Top Color	Edge Color	Shell Color	
 <p>Bookcase Unit with Shelves</p> <ul style="list-style-type: none"> Laminate top (1-1/4" with 74P edge) Dual sided storage 3 compartments per side (6 total) Unit ships assembled; glides/casters are field installed 	36x24x36	RKB362436	<input type="checkbox"/> <input type="checkbox"/>	<input type="checkbox"/> <input type="checkbox"/>	<input type="checkbox"/> <input type="checkbox"/>	<input type="checkbox"/> <input type="checkbox"/>	161.0#
	36x24x42	RKB362442	<input type="checkbox"/> <input type="checkbox"/>	<input type="checkbox"/> <input type="checkbox"/>	<input type="checkbox"/> <input type="checkbox"/>	<input type="checkbox"/> <input type="checkbox"/>	170.6#

RCKB

A **B** **C** **D** **E**

HOW TO ORDER

Indicate the following information on order form:

- Quantity of each item.
- Model number, including options. See "How To Build a Model Number".
- Any special service required.

Note: • The indicates that a choice is required.

- The absence of the indicates that no choice is required.
- Alpha-numeric characters in place of indicate that no other alternatives are available.

HOW TO BUILD A MODEL NUMBER

- A** Select basic model.
- B** Select base option.

4CW	- 4 black casters
4GB	- 4 black glides
- C** Select top laminate surface. Refer to color addendum at ki.com or KI Fabrics & Finishes binder.
- D** Select edge color. Refer to color addendum at ki.com or KI Fabrics & Finishes binder.
- E** Select shell color. Refer to color addendum at ki.com or KI Fabrics & Finishes binder.

FINISH INFORMATION

Additional Laminate Offering

Additional laminates beyond KI standard offering, are available with two weeks extended leadtime. To specify additional laminates, use these designators followed by the supplier's color/pattern code:

Formica - LF/supplier's color pattern code
 Nevamar - LN/supplier's color pattern code
 Wilsonart - LW/supplier's color pattern code

KI's standard finish is the supplier's recommended finish for that color/pattern. Note: Nonstandard laminates from these suppliers (example: textured laminates), require an upcharge and additional leadtime. Contact KI.



Ruckus™ Storage (Delivered Pricing)

Bookcase

Delivered Pricing

\$ 997

1047

SPECIAL SERVICES

Special Carton Marking

With specially marked information N/C

Shipping

Shipped **assembled freight prepaid f.o.b. Pembroke, Ontario K8A 0E1** factory. Freight class #100.

Specifications and prices are subject to change without prior notice.

Ruckus™ Storage (Delivered Pricing)

Cubbies

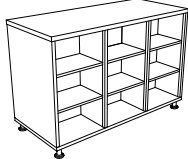
	MODEL	W x D x H	MODEL NUMBER					Approx. Packaged Weight
			Basic Model	Base	Top Color	Edge Color	Shell Color	
	Cubbies 2x3-Open Units • Laminate top (1-1/4" with 74P edge) • Dual sided storage (12 total compartments) • Unit ships assembled; glides/casters are field installed	36x24x36	RKC362436OP	<input type="checkbox"/> <input type="checkbox"/> <input type="checkbox"/>	<input type="checkbox"/> <input type="checkbox"/> <input type="checkbox"/>	<input type="checkbox"/> <input type="checkbox"/> <input type="checkbox"/>	<input type="checkbox"/> <input type="checkbox"/>	181.4#
		36x24x42	RKC362442OP	<input type="checkbox"/> <input type="checkbox"/> <input type="checkbox"/>	<input type="checkbox"/> <input type="checkbox"/> <input type="checkbox"/>	<input type="checkbox"/> <input type="checkbox"/> <input type="checkbox"/>	<input type="checkbox"/> <input type="checkbox"/>	194.6#
RCKC								
	Cubbies 3x3-Open Units • Laminate top (1-1/4" with 74P edge) • Dual sided storage (18 total compartments) • Unit ships assembled; glides/casters are field installed	54x24x36	RKC542436OP	<input type="checkbox"/> <input type="checkbox"/> <input type="checkbox"/>	<input type="checkbox"/> <input type="checkbox"/> <input type="checkbox"/>	<input type="checkbox"/> <input type="checkbox"/> <input type="checkbox"/>	<input type="checkbox"/> <input type="checkbox"/>	235.2#
		54x24x42	RKC542442OP	<input type="checkbox"/> <input type="checkbox"/> <input type="checkbox"/>	<input type="checkbox"/> <input type="checkbox"/> <input type="checkbox"/>	<input type="checkbox"/> <input type="checkbox"/> <input type="checkbox"/>	<input type="checkbox"/> <input type="checkbox"/>	253.1#
RCKC								
				A	B	C	D	E

HOW TO ORDER

Indicate the following information on order form:

- Quantity of each item.
- Model number, including options. See "How To Build a Model Number".
- Any special service required.

Note: • The indicates that a choice is required.

- The absence of the indicates that no choice is required.
- Alpha-numeric characters in place of indicate that no other alternatives are available.

HOW TO BUILD A MODEL NUMBER

- A** Select basic model.
- B** Select base option.
- | | |
|------------|-------------------|
| 4CW | - 4 black casters |
| 4GB | - 4 black glides |
- C** Select top laminate surface.
Refer to color addendum at ki.com or KI Fabrics & Finishes binder.
- D** Select edge color.
Refer to color addendum at ki.com or KI Fabrics & Finishes binder.
- E** Select shell color.
Refer to color addendum at ki.com or KI Fabrics & Finishes binder.

FINISH INFORMATION

Additional Laminate Offering

Additional laminates beyond KI standard offering, are available with two weeks extended leadtime. To specify additional laminates, use these designators followed by the supplier's color/pattern code:

Formica - LF/supplier's color pattern code
 Nevamar - LN/supplier's color pattern code
 Wilsonart - LW/supplier's color pattern code

KI's standard finish is the supplier's recommended finish for that color/pattern. Note: Nonstandard laminates from these suppliers (example: textured laminates), require an upcharge and additional leadtime. Contact KI.



Ruckus™ Storage (Delivered Pricing)

Cubbies

Delivered Pricing

\$ 1058

1095

\$ 1378

1428

SPECIAL SERVICES

Special Carton Marking

With specially marked information N/C

Shipping

Shipped **assembled freight prepaid f.o.b. Pembroke, Ontario K8A 0E1** factory. Freight class #100.

Specifications and prices are subject to change without prior notice.

Ruckus™ Storage (Delivered Pricing)

Cubbies

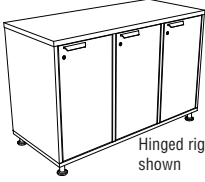
	W x D x H	MODEL NUMBER									Approx. Packaged Weight	
		Basic Model	Door Lock Option	Pull Option	Base	Top Color	Edge Color	Shell Color	Door Color	Lock Option		
 <p>Hinged right shown</p> <p>RCKC Cubbies 2x3-With Doors</p> <ul style="list-style-type: none"> Laminate top (1-1/4" with 74P edge) Dual sided storage (12 total compartments) Secure locking doors 4 Locking options offered Unit ships assembled; glides/casters are field installed 	36x24x36	RKC362436DR	<input type="checkbox"/> <input type="checkbox"/> <input type="checkbox"/> <input type="checkbox"/>	<input type="checkbox"/> <input type="checkbox"/>	<input type="checkbox"/> <input type="checkbox"/>	<input type="checkbox"/> <input type="checkbox"/>	<input type="checkbox"/> <input type="checkbox"/>	<input type="checkbox"/> <input type="checkbox"/>	<input type="checkbox"/> <input type="checkbox"/>	<input type="checkbox"/> <input type="checkbox"/>	208.2#	
	36x24x42	RKC362442DR	<input type="checkbox"/> <input type="checkbox"/> <input type="checkbox"/> <input type="checkbox"/>	<input type="checkbox"/> <input type="checkbox"/>	<input type="checkbox"/> <input type="checkbox"/>	<input type="checkbox"/> <input type="checkbox"/>	<input type="checkbox"/> <input type="checkbox"/>	<input type="checkbox"/> <input type="checkbox"/>	<input type="checkbox"/> <input type="checkbox"/>	<input type="checkbox"/> <input type="checkbox"/>	<input type="checkbox"/> <input type="checkbox"/>	226.0#
 <p>Hinged right shown</p> <p>RCKC Cubbies 3x3-With Doors</p> <ul style="list-style-type: none"> Laminate top (1-1/4" with 74P edge) Dual sided storage (18 total compartments) Secure locking doors 4 Locking options offered Unit ships assembled; glides/casters are field installed 	54x24x36	RKC542436DR	<input type="checkbox"/> <input type="checkbox"/> <input type="checkbox"/> <input type="checkbox"/>	<input type="checkbox"/> <input type="checkbox"/>	<input type="checkbox"/> <input type="checkbox"/>	<input type="checkbox"/> <input type="checkbox"/>	<input type="checkbox"/> <input type="checkbox"/>	<input type="checkbox"/> <input type="checkbox"/>	<input type="checkbox"/> <input type="checkbox"/>	<input type="checkbox"/> <input type="checkbox"/>	275.4#	
	54x24x42	RKC542442DR	<input type="checkbox"/> <input type="checkbox"/> <input type="checkbox"/> <input type="checkbox"/>	<input type="checkbox"/> <input type="checkbox"/>	<input type="checkbox"/> <input type="checkbox"/>	<input type="checkbox"/> <input type="checkbox"/>	<input type="checkbox"/> <input type="checkbox"/>	<input type="checkbox"/> <input type="checkbox"/>	<input type="checkbox"/> <input type="checkbox"/>	<input type="checkbox"/> <input type="checkbox"/>	<input type="checkbox"/> <input type="checkbox"/>	300.3#
			A	B	C	D	E	F	G	H	I	

HOW TO ORDER

Indicate the following information on order form:

- Quantity of each item.
- Model number, including options. See "How To Build a Model Number".
- Any special service required.

Note: • The indicates that a choice is required.

- The absence of the indicates that no choice is required.
- Alpha-numeric characters in place of indicate that no other alternatives are available.

HOW TO BUILD A MODEL NUMBER

- A** Select basic model.
- B** Select door lock option.
 - SLCKL** - Standard lock hinged left
 - SLCKR** - Standard lock hinged right
 - PLCKL** - Padlock hinged left
 - PLCKR** - Padlock hinged right
 - CLCKL** - Combination lock hinged left
 - CLCKR** - Combination lock hinged right
 - DLCKL** - Digital lock hinged left
 - DLCKR** - Digital lock hinged right
- C** Select pull option.
 - S6** - Beveled pull Black
 - S5** - Beveled pull Satin Chrome
 Pull selection only when SLCKR or SLCKL key lock is selected.
- D** Select base option.
 - 4CW** - 4 black casters
 - 4GB** - 4 black glides

- E** Select top laminate surface. Refer to color addendum at ki.com or KI Fabrics & Finishes binder.
- F** Select edge color. Refer to color addendum at ki.com or KI Fabrics & Finishes binder.
- G** Select shell color. Refer to color addendum at ki.com or KI Fabrics & Finishes binder.
- H** Select front door color. Refer to color addendum at ki.com or KI Fabrics & Finishes binder.
- I** Select lock option
 - KA** - Key alike
 - KS** - Key standard
 - NLC** - No lock core
 Available ONLY when the standard lock is selected.

FINISH INFORMATION

Additional Laminate Offering

Additional laminates beyond KI standard offering, are available with two weeks extended leadtime. To specify additional laminates, use these designators followed by the supplier's color/pattern code:

Formica - LF/supplier's color pattern code
 Nevamar - LN/supplier's color pattern code
 Wilsonart - LW/supplier's color pattern code

KI's standard finish is the supplier's recommended finish for that color/pattern. Note: Nonstandard laminates from these suppliers (example: textured laminates), require an upcharge and additional leadtime. Contact KI.



Ruckus™ Storage (Delivered Pricing)

Cubbies

Delivered Pricing Standard Lock	Delivered Pricing Padlock	Delivered Pricing Combination Lock	Delivered Pricing Digital Lock
\$ 1382	\$ 1419	\$ 1698	\$ 2245
1428	1465	1744	2291

\$ 1838	\$ 1895	\$ 2312	\$ 3133
1900	1957	2375	3195

SPECIAL SERVICES

Special Carton Marking

With specially marked information N/C

Shipping

Shipped **assembled freight prepaid f.o.b. Pembroke, Ontario K8A 0E1** factory. Freight class #100.

Specifications and prices are subject to change without prior notice.

Ruckus™ Storage (Delivered Pricing)

Storage Accessories

	MODEL	Features	MODEL NUMBER	
			Basic Model	Approx. Packaged Weight
HRDPT	Double Bit Keys	Master Key	2.KP20550	0.2#
		Extractor Key	2.KP20551	0.2#
		Key Blank	2.KP20552	0.2#
		Cut Key	2.KP20557	0.2#
HRDPT	Locker Master Key for CLCK Lock	<ul style="list-style-type: none"> Master key for CLCK combination locks used on Ruckus storage lockers and cubbies ONLY Not for use with any other locks except Ruckus combination locks 	2.KP61614	0.2#
HRDPT	Locker Master Key for DLCK Lock	<ul style="list-style-type: none"> Master key for DLCK digital locks used on Ruckus storage lockers and cubbies ONLY Not for use with any other locks except Ruckus digital locks 	2.KP61616	0.2#

A

HOW TO ORDER

Indicate the following information on order form:

- Quantity of each item.
- Model number, including options. See "How To Build a Model Number".
- Any special service required.

Note: • The indicates that a choice is required.

- The absence of the indicates that no choice is required.
- Alpha-numeric characters in place of indicate that no other alternatives are available.

HOW TO BUILD A MODEL NUMBER

A Select basic model.



Ruckus™ Storage (Delivered Pricing)

Storage Accessories

Delivered
Pricing

\$ 9
9
3
4
\$ 21

\$ 7

SPECIAL SERVICES

Special Carton Marking

With specially marked information N/C

Shipping

Shipped **assembled freight prepaid f.o.b. Pembroke, Ontario K8A 0E1** factory. Freight class #70.

Specifications and prices are subject to change without prior notice.

Index

Model No.	Description	Page
2.KP20550	Storage Accessories: Double Bit Keys	46
2.KP61614	Storage Accessories: Locker Master Key for CLCK Lock	46
2.KP61616	Storage Accessories: Locker Master Key for CLCK Lock	46
RK1100H15NB	Four-Leg Chair: Four-Leg Chair with Glides	14
RK1200H15NB	Four-Leg Chair: Four-Leg Chair with Glides	14
RK2100H15NB	Four-Leg Chair: Four-Leg Chair with Casters	16
RK2200H15NB	Four-Leg Chair: Four-Leg Chair with Casters	16
RK4100H24BR	Stools: Stool with Bookrack	28
RK4100H24NB	Stools: Stool No Bookrack	26
RK4200H24BR	Stools: Stool with Bookrack	28
RK4200H24NB	Stools: Stool No Bookrack	26
RK5100	Task Chair: Task Chair	30
RK5200	Task Chair: Task Chair	30
RKB/362436	Bookcase: Bookcase Unit with Shelves	40
RKC/362436DR	Cubbies: Cubbies 2x3-With Doors	44
RKC/362436OP	Cubbies: Cubbies 2x3-Open Units	42
RKC/542436DR	Cubbies: Cubbies 3x3-With Doors	44
RKC/542436OP	Cubbies: Cubbies 3x3-Open Units	42
RKL/362436DR	Lockers: Locker-Two Door Units	38
RKL/362436OP	Lockers: Locker-Two Open Units	36
RKL/542436DR	Lockers: Locker-Three Door Units	38
RKL/542436OP	Lockers: Locker-Three Open Units	36
RKU100H15BR	Stack Chair with Glides: Stack Chair with Glides and Bookrack	20
RKU100H15NB	Stack Chair with Glides: Stack Chair with Glides	18
RKU200H15BR	Stack Chair with Glides: Stack Chair with Glides and Bookrack	20
RKU200H15NB	Stack Chair with Glides: Stack Chair with Glides	18
RKV100H15BR	Stack Chair with Casters: Stack Chair with Casters and Bookrack	24
RKV100H15NB	Stack Chair with Casters: Stack Chair with Casters	22
RKV200H15BR	Stack Chair with Casters: Stack Chair with Casters and Bookrack	24
RKV200H15NB	Stack Chair with Casters: Stack Chair with Casters	22
RU4207	Desk: Fixed Height - Glide Base	32
RU5207	Desk: Fixed Height - Rolling Base	34



KI
1330 Bellevue Street
P.O. Box 8100
Green Bay, Wisconsin 54308-8100
1-800-424-2432
www.ki.com

KI and Furnishing Knowledge
are registered trademarks
of Krueger International, Inc.

© 2017 Krueger International, Inc.
All Rights Reserved.
Code KI-PLW-000010/KI/PDF/0217